



INSTRUCTIONS

MODE D'EMPLOI

BEDIENUNGSANLEITUNG

MANUALE D'USO

INSTRUCCIONES DE USO

DIAL GAUGE **E**

COMPARATEUR **F**

MESSUHR **D**

COMPARATORE **I**

COMPARADOR **S**

**Installing and replacing the battery
(or Power cable)**

Mise en place et remplacement de la
batterie (ou câble Power)

**Einbau und Austausch von Batterie
(oder Netzkabel)**

Installazione e sostituzione della batteria
(o del cavo di alimentazione)

**Colocación y sustitución de la batería
(o cable Power)**



No. 0 

No. 0 (0,4x2,5mm) 



Battery / batterie / **Batterie** / batteria / **bateria**: lithium 3V, type CR2032

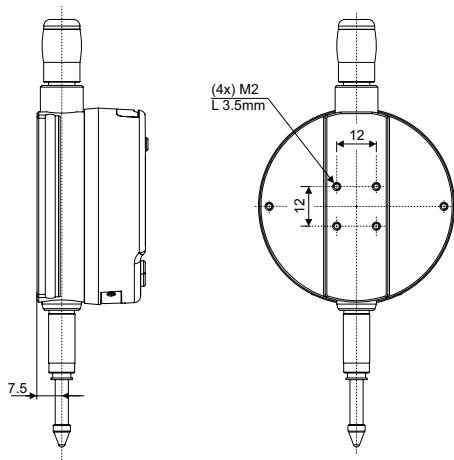

Diagram for rear fixings

Schéma de fixation arrière

Schema für die Befestigung hinten

Schema di fissaggio posteriore

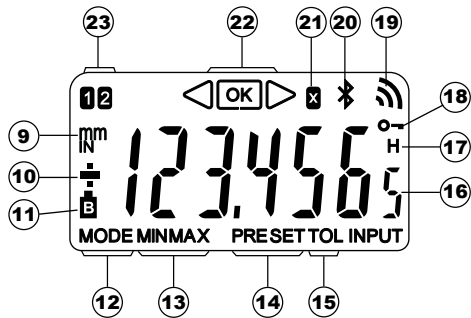
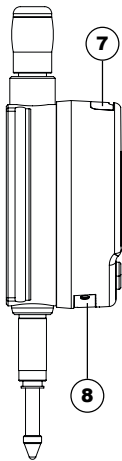
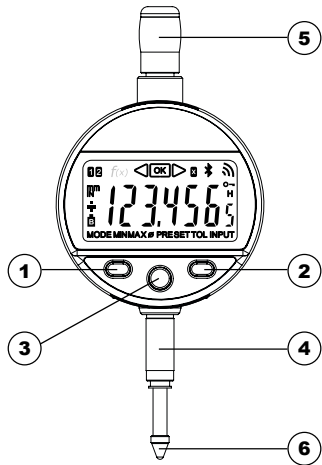

Esquema de fijación posterior



Description

1. MODE button
2. SET button
3. "Favourite" button
4. Clamping shaft $\varnothing 8$ or 3/8"
5. Lifting cap
6. Contact point $\varnothing 2 / M2.5$ or 4-48-UNF
7. Slot for Proximity cable
8. Slot for battery or Power cable
9. Measurement units (mm/INCH)
10. +/- Indicator
11. Low battery
12. Mode menu display
13. MIN/MAX/DELTA mode
14. Preset mode
15. Tolerance mode
16. 7- digit display
17. Hold measured value
18. Keypad lock
19. Send data
20. *Bluetooth*[®] active (depending on model)
21. Multiplication factor
22. Tolerance indicators
23. Active reference

1. Operating features of the instrument

-  The instrument has two operating modes: basic functions (direct access) and advanced functions. In addition to the configuration functions, 2 working reference functions can be accessed, in MIN, MAX and DELTA (TIR) mode, plus tolerance display or input of multiplication factor other than 1:1 (see chaps. 3 and 4).
-  The «favourite» key gives direct access to the function used most often (see chap. 7).
-  Sets a Preset value, resets the MIN/MAX mode, verifies a selection, and controls switching off the instrument. By default, SIS mode enables automatic switch-off with no loss of origin (see chap. 8).

- Personalising the functions

It is possible to activate or de-activate certain functions of the instrument via RS232 (see chap. 10).

- Data transmission parameters

4800Bds, 7 bits, even parity, 2 stop bits.

2. Start

Press a button.

For a *Bluetooth*[®] connection (see chap. 6).

3. Basic functions

Each short press on  gives direct access to the basic functions :

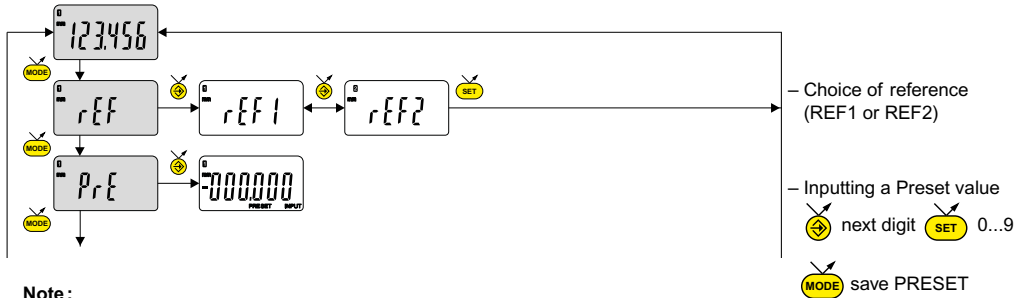

Note :

- It is possible to assign a different preset value to each of the 2 References. Similarly, different tolerance limits can be assigned to References 1 and 2.

..... continuation

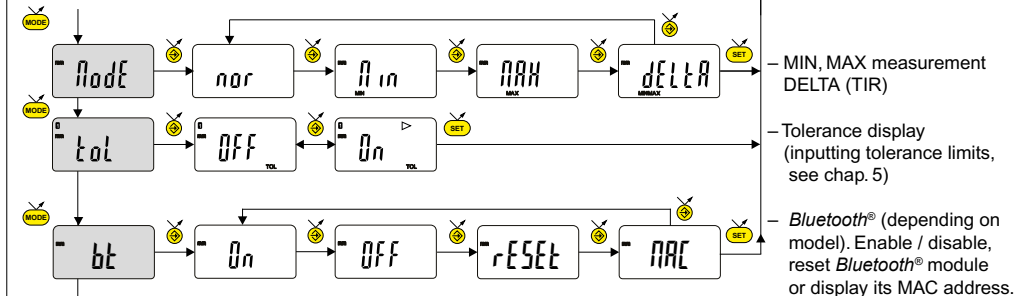

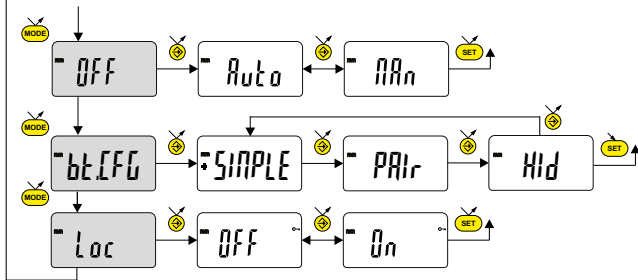

..... continuation



- Automatic switch-off mode
 NAN = disabled. $Auto$ = active
 (after 10 min. by default).

- *Bluetooth*[®] profile selection (depending on model).
 (see chap. 6 for details)
 The + sign indicates the currently active profile.

- Keypad lock
 Only the favourite key  remains active. (to unlock the keypad, press  for 5 sec).

5. Inputting tolerance limits

To input or modify the tolerance limits, tOL mode should be selected, followed by a short press on  :

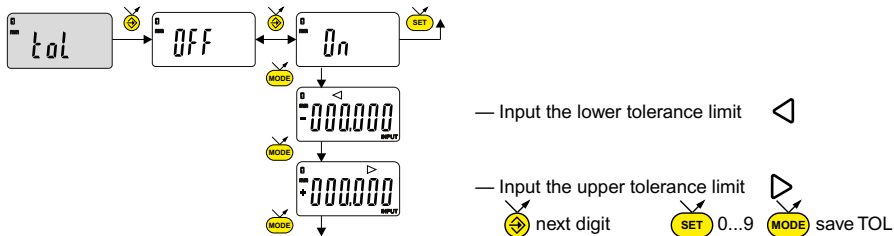



Note :

- For measuring internal dimensions, the red and yellow indicators can be switched over by reversing the order in which the tolerance limits are input (lower limit > upper limit).
- It is possible to input different tolerances on REF1 and REF2.

- It is also possible to display the tolerance limits when the instrument is operating in MIN, MAX or DELTA (TIR) mode.
- If no tolerance limits have been defined by the user, the instrument will only display the tolerance limit indicators ◀ OK ▶ but will not turn on the indicator lights (red - green - yellow).

6. *Bluetooth*[®] configuration (depending on model)

The connection procedure has been designed to be simple and is signalled by the following three states:

- Symbol  off disconnected mode
- Symbol  blinking..... advertising mode
- Symbol  on..... connected mode

The following options can be selected to control the *Bluetooth*[®] module.

- On** Enable *Bluetooth*[®] module (start advertising mode).
- OFF** Disable *Bluetooth*[®] module (terminate active connection).
- rESEt** Clear pairing information.
- MAC** Display the MAC (Media Access Control) address.

Three Bluetooth® profiles are available.

SIMPLE Profile without pairing (default).

PAIR Paired and secured profile.

Hid Virtual keyboard mode (compatible with recent equipment without driver installation).

Note:

- *Bluetooth*® pairing information is cleared when the profile is changed.

Connection :

- 1 Activate *Bluetooth*® compatible software and hardware (Master : PC, Display Unit).
- 2 Start the instrument. By default the *Bluetooth*® module is active and the instrument is available for connection (advertising mode).
- 3 If no connection is established during the advertisement period reactivate the *Bluetooth*® module using the *bt / On* menu.
- 4 Instrument is ready to communicate (connected mode.)

Only with paired profile :

Pairing with master is automatically done at first connection.

To connect the instrument to a new master (new pairing), pairing information on the instrument must be cleared using the *bt / reset* menu.

6.1 *Bluetooth*[®] specifications

| | |
|------------------|---|
| Frequency Band | 2.4GHz (2.402 - 2.480GHz) |
| Modulation | GFSK (Gaussian Frequency Shift Keying) |
| Max Output Power | Class 3: 1mW (0dBm) |
| Range | Open space: up to 15m Industrial environment: 1-5m |
| Battery life | Continuous : up to 2 months - Always connected with 4 values /sec. Saver : up to 5 months - The instrument sends value only when the position has changed. Blind/Push : up to 7 months - Value is sent from the instrument (button) or requested from the computer. |



Other specifications on the manufacturer's website.

7. Favourite key

The «favourite» key gives direct access to a predefined function, and can be configured according to the needs of the user.

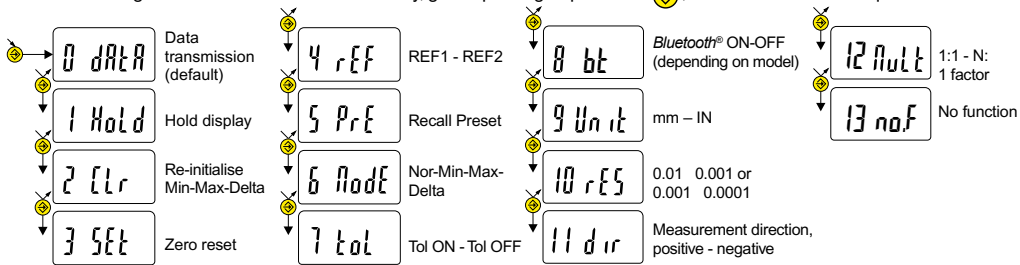
In order to assign a function to the «favourite» key, give a prolonged press on , and then select the required function:



Validation of selection: By a prolonged press on  or a short press on  or .

Note:

- A function can also be assigned via RS232 using the command <FCT + Function No.> (FCT 0..9 A..F)
example: Toggle unit = <FCT9>, reverse measurement direction = <FCTB>.

8. Switching off

The dial gauge goes automatically into stand-by if not used for 10 minutes, unless automatic switch-off mode has been turned off (see Chap. 4, advanced functions).

Stand-by mode can be forced by a prolonged press (> 2 sec) on  :

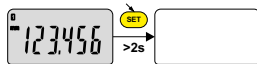



In stand-by mode, the value of the origin is retained by the sensor (SIS mode), and the instrument automatically restarts with any movement of the measurement probe, RS command, *Bluetooth*[®] request or press on button.

The instrument can be switched off completely for a long period of non-use, but this will necessitate a zero reset on restart (the origin will be lost):



9. Re-initialising the instrument

The initial instrument settings can be restored at any time by a prolonged press (>4 sec) simultaneously on  and  until the message *reset* is displayed.

10. Personalising the instrument

Access to the functions of your instrument can be personalised, for more information see manufacturer's website (requires you to connect your instrument via Proximity or Power RS / USB cable, or *Bluetooth*[®]).

Possibilities:

- Enable or disable the required functions.
- Modify access to the advanced functions (direct access).

11. Connecting the instrument

The instrument can be connected to a peripheral via a Proximity (RS or USB), Power (RS or USB) cable or *Bluetooth*[®]. See page 2 for connecting the Power cable.

Measured values can be transmitted and the instrument driven using predefined commands (see chap. 12 for a list of the main commands).

Note:

- In Tolerance mode, the tolerance limit lights remain lit only for a few seconds while the measurement stabilises. On the other hand, they will remain lit continuously if the instrument is connected to, and powered by, the Power RS (USB) cable.

12. List of the main commands

Selection and configuration

| | |
|---------------------------|--|
| CHA+ / CHA- | Change measurement direction |
| FCT0 ...9...A...F | Assign «favourite» function |
| MM / IN | Change measurement unit |
| KEY0 / KEY1 | Lock / unlock keypad |
| MUL [+/-]xxx.xxxx | Modify multiplication factor |
| PRE [+/-]xxx.xxx | Modify preset value |
| REF1 / REF2 | Change active reference |
| STO1 / STO0 | Activate / de-activate HOLD |
| TOL1 / TOL0 | Activate / de-activate tolerances |
| ECO1 / ECO 0 | Activate / de-activate economic mode |
| LCAL dd.mm.yy | Modify last calibration date |
| NCAL dd.mm.yy | Modify next calibration date |
| NUM x...x (up to 20chars) | Modify the instrument number |
| TOL +/-xxx.xxx +/-yyy.yyy | Inputting tolerance limits |
| MIN /MAX /DEL /NOR | Selecting MIN, MAX, Delta, Normal mode |
| CLE | Re-initialisation of MIN, MAX or Delta |
| UNI1 / UNIO | Activate / de-activate change of units |
| OUT1 /OUT0 | Activate / de-activate contin. data transmission |

| | |
|--------------------|--|
| PRE ON / PRE OFF | Activate / de-activate Preset function |
| PRE | Recall Preset |
| SET | Zero reset |
| RES1 / RES2 / RES3 | Change of resolution |

SBY xx xx number of minutes before stand-by

| | |
|---------|---|
| BT0/BT1 | Activate / de-activate <i>Bluetooth</i> [®] module |
| BTRST | Clear pairing information |

Interrogation

| | |
|-------|---|
| CHA? | Measurement direction? |
| FCT? | «favourite» function active? |
| UNI? | Measurement unit active? |
| KEY? | Keypad locked? |
| MUL? | Multiplication factor? |
| PRE? | Preset value? |
| REF? | Reference active? |
| STO? | Status of HOLD function? |
| TOL? | Current tolerance limit values? |
| ECO? | Current economic mode |
| LCAL? | Date of last calibration? |
| NCAL? | Date of next calibration? |
| NUM? | Instrument number? |
| ? | Current value (mode Tol, value followed by <=>) |
| MOD? | Active mode (MIN, MAX, Delta or Normal)? |
| SET? | Main instrument parameters? |
| ID? | Instrument identification code? |

Maintenance functions

| | |
|------|--|
| BAT? | Battery status (BAT1 = OK, BAT0 = low battery) |
| OFF | Switch-off (wake up using a button or RS) |
| RST | Re-initialisation of the instrument |
| SBY | Put instrument in stand-by (SIS) |
| VER? | Version No. and date of firmware |

MAC? *Bluetooth*[®] MAC address ?

13. Specifications

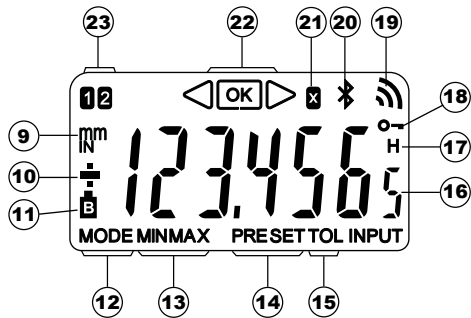
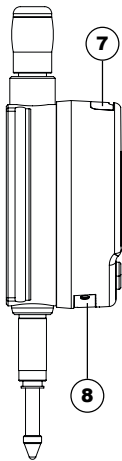
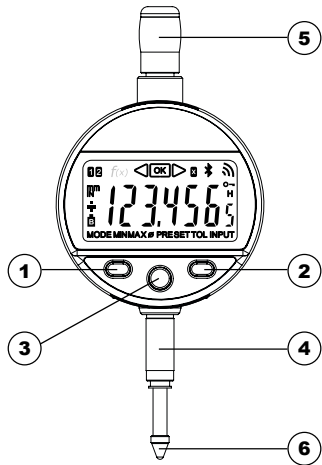

| | | | | | | |
|--|---|------------|-----------|----------|----------|------------|
| Measurement range: | 12.5mm | 25mm | 50mm | 100mm | 150mm | |
| Max error (10µm resolution): | 10µm | 10µm | 20µm | 20µm | 20µm | (±1 digit) |
| Max error (1µm resolution): | 3µm | 4µm | 5µm | 6µm | 10µm | |
| Max error (0.1µm resolution): | 1.2µm | 1.6µm | --- | --- | --- | |
| Repeatability: | 2µm 0.3µm (model 0.0001mm scale) | | | | | |
| Weight: | 119g | 123g | 161g | 208g | 265g | |
| Measurement force (standard): | 0.65-0.9N | 0.65-1.15N | 1.25-2.7N | 1.6-3.5N | 2.2-5.7N | |
| Max. speed of travel: | 1.7m/s | | | | | |
| No. of measurements / second: | up to 10 meas/s MIN/MAX mode: up to 20 meas/s | | | | | |
| Measurement unit: | metric/english (Inch) | | | | | |
| Maximum Preset (10µm resolution): | ±9999.99 mm / ±399.9995 IN | | | | | |
| Maximum Preset (1µm resolution): | ±999.999 mm / ±39.99995 IN | | | | | |
| Maximum Preset (0.1µm resolution): | ±99.9999 mm / ±3.999995 IN | | | | | |
| Measurement system: | Sylvac inductive system (patented) | | | | | |
| Power: | 1 x 3V lithium battery, type CR2032, 220mAh | | | | | |
| Average battery life: | 8'000 hours (with <i>Bluetooth</i> ® enabled, see chapter 6.1) | | | | | |
| Data output: | RS232 compatible / <i>Bluetooth</i> ® 4.0 (see chapter 6) | | | | | |
| Working temperature (storage): | +5 to +40 C (-10 to +60 C) | | | | | |
| Electromagnetic compatibility: | as per EN 61326-1 | | | | | |
| IP rating (in accordance with IEC60529): | IP 54 / IP 67 (depending on model) | | | | | |
| Fixing and space envelope: | Ø8h6 (3/8"), interchangeable M2.5 (4-48-UNF) probe (as per DIN 878) | | | | | |

F

Description

1. Bouton MODE
2. Bouton SET
3. Bouton "Favoris"
4. Canon de fixation Ø8 ou 3/8"
5. Bonnette de relevage
6. Touche à bille Ø2/M2.5 ou 4-48-UNF
7. Logement pour câble Proximity
8. Logement batterie ou câble Power
9. Unité de mesure (mm/INCH)
10. Indicateur +/-
11. Batterie faible
12. Indication du menu MODE
13. Mode MIN/MAX/DELTA
14. Mode Preset
15. Mode tolérance actif
16. Affichage - digits
17. Gel de la valeur de mesure
18. Verrouillage des boutons
19. Envoi de données
20. Connexion *Bluetooth*[®] (dépendant de la version)
21. Facteur de multiplication
22. Indicateur des tolérances
23. Indicateur de la référence active

1. Les fonctionnalités de l'instrument

-  L'instrument possède 2 modes de travail : fonctions de base (avec accès direct) et fonctions avancées. En plus des fonctions de configuration, vous pouvez accéder à 2 référence de travail, au mode MIN, MAX et DELTA (TIR), à l'affichage des tolérances, ou à l'introduction d'un facteur de multiplication (voir chap. 3 et 4).
-  Le bouton «favori» permet d'attribuer un accès direct à la fonction principalement utilisée (voir chap. 7).
-  Le bouton «SET» permet d'attribuer une valeur de Preset, de réinitialiser le mode MIN/MAX, de quitter une sélection, et de gérer l'extinction de l'instrument. Par défaut, le mode SIS permet l'extinction automatique sans perte de l'origine (voir chap. 8).
- **Personnalisation des fonctions**
Vous avez la possibilité d'activer ou désactiver certaines fonctions de l'instrument par RS232 (voir chap. 10).
- **Paramètres de transmission de données**
4800Bds, 7 bits, parité paire, 2 stop bits.

2. Démarrer

Presser un bouton.

Pour une connexion *Bluetooth*[®] (voir chap. 6).

3. Fonctions de base

Chaque pression courte sur  permet un accès direct aux fonctions de base :

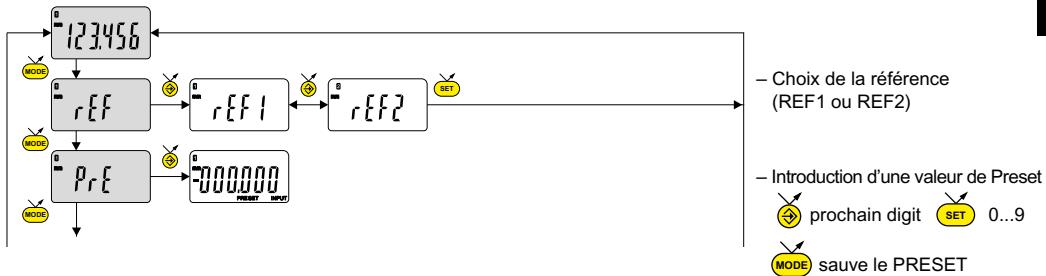

Remarque :

- Il est possible d'attribuer une valeur de preset différente à chacune des 2 Références. De même, on peut attribuer des limites de tolérances différentes sur les références 1 et 2.

..... suite

F

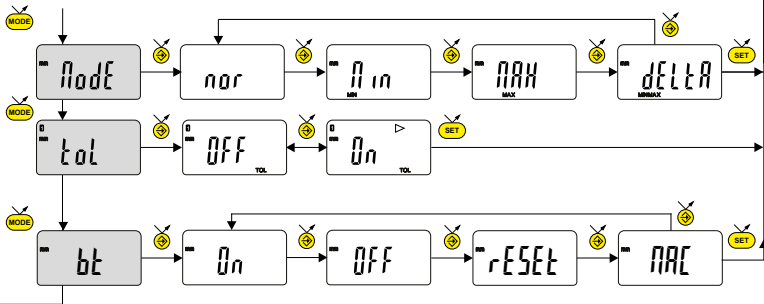



- Mesure du MIN, MAX et DELTA (TIR)

- Affichage des tolérances (introduction des limites de, tolérance, voir chap. 5)

- Bluetooth® (selon version). Activation / désactivation, réinitialisation du module Bluetooth® ou affichage de l'adresse MAC.

4. Fonctions avancées

Une pression longue (>2s) sur  permet d'accéder aux fonctions avancées. Puis, chaque pression courte sur  accède à la fonction souhaitée :

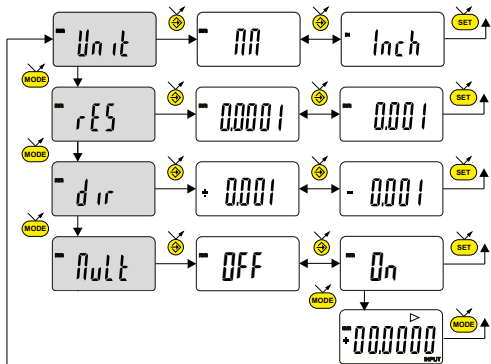



– Sélection de l'unité (mm or inch)

– Choix de la résolution 0.01 / 0.001 or 0.001 / 0.0001 (dependant de la version)

– Choix de la direction de mesure (sens positif ou négatif)

– Facteur de multiplication, active ou désactive le facteur de multiplication. (la valeur peut être modifiée si **On** est confirmé avec le bouton )

– Introduction d'un facteur de multiplication

 prochain digit  0...9  sauver MULT

F

..... suite

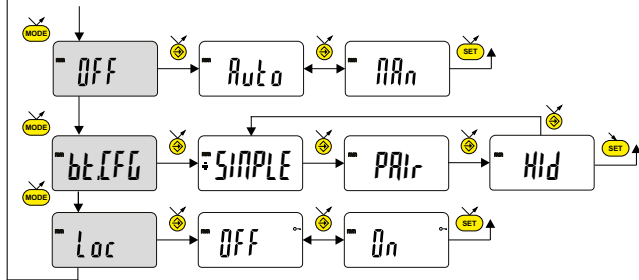

- Mode d'extinction automatique
Off = désactivé, Auto = actif (après 10 min. par défaut).

- Sélection du profil Bluetooth® (dépendant de la version).
(Voir chap. 6 pour plus de détails).
Le symbole + indique le profil actif.

- Blocage du clavier
Seule la touche favori (yellow circle with right arrow) reste active (pour désactiver le blocage du clavier, presser SET pendant 5 sec).

5. Introduction des limites de tolérances

Pour introduire ou modifier les limites de tolérances, il faut sélectionner le mode tol On , suivi d'une pression courte sur  :

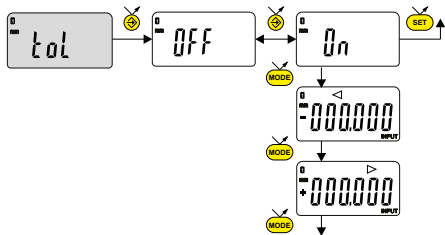

– Introduire la limite de tolérance inférieure ◀

– Introduire la limite de tolérance supérieure ▶

 prochain digit  0...9  sauve le TOL

Remarque :

- Dans le cas de mesure de cotes d'intérieur, on peut croiser les indicateurs (rouge et jaune) en inversant l'ordre d'introduction des limites de tolérances (limite inférieure > limite supérieure).
- Il est possible d'introduire des limites de tolérances différentes sur les REF1 et REF2.

- Il est également possible d'afficher les limites de tolérance lorsque l'instrument travaille en mode MIN, MAX ou DELTA (TIR).
- Si aucune limites de tolérance n'ont été définies par l'utilisateur, l'instrument affichera les indicateurs de limites de tolérances ◀ [OK] ▶ , mais sans activer les indicateurs lumineux (rouge - vert - jaune).

F

6. Configuration *Bluetooth*[®] (selon modèle)

La procédure de connexion a été pensée au plus simple et se distingue par les 3 états ci-dessous:

- Symbole ✖ éteint..... mode déconnecté.
- Symbole ✖ clignote mode découverte.
- Symbole ✖ allumé mode connecté.

Les options suivantes peuvent être sélectionnées pour contrôler le module *Bluetooth*[®].

- On Activer le module *Bluetooth*[®] (démarrer le mode découverte).
- OFF Désactiver le module *Bluetooth*[®] (terminer la connexion active).
- rESEt Effacer les informations d'appairage.
- MAC Afficher l'adresse MAC (Media Access Control).

Trois profils *Bluetooth*[®] sont disponibles.

SIMPLE Profil non appairé (par défaut).

PAIR Profil appairé et sécurisé.

Hid Mode clavier virtuel (compatible avec un équipement récent sans installation d'un pilote).

- Remarque:

Les informations d'appairage *Bluetooth*[®] sont effacées lorsque le profil est modifié.

Connexion :

- 1 S'assurer que l'application et le matériel *Bluetooth*[®] compatibles sont actifs (PC, unité de mesure).
- 2 Démarrer l'instrument. Par défaut le module *Bluetooth*[®] est actif et l'instrument est connectable (mode découverte).
- 3 Dès que l'instrument est détecté la connexion est automatique. Si la connexion n'a pas été établie pendant que l'instrument se trouvait en mode découverte, réactiver le module *Bluetooth*[®] via le menu *bt / On*.
- 4 L'instrument est prêt à transmettre (mode connecté).

Seulement avec le profil d'appairage :

L'appairage de l'instrument avec le maître se fait automatiquement à la première connexion.

Pour connecter un instrument à un nouveau maître (nouvel appairage), les informations d'appairage doivent être effacées via le menu *bt / rESET*.



6.1 Spécification *Bluetooth*[®]

| | |
|--------------------------|--|
| Bande de fréquence | 2.4GHz (2.402 - 2.480GHz) |
| Modulation | GFSK (Gaussian Frequency Shift Keying) |
| Puissance de sortie max. | Classe 3: 1mW (0dBm) |
| Portée | Espace ouvert : jusqu'à 15m Environnement industriel : 1-5m |
| Autonomie | Continuous : Jusqu'à 2 mois - Toujours connecté avec 4 valeurs /sec. Saver : jusqu'à 5 mois - L'instrument envoie la valeur quand la position change. Blind/Push : jusqu'à 7 mois - La valeur est envoyée de l'instrument (bouton) ou demandée par ordinateur. |

Autre spécifications sur le site du fabricant.

7. Touche favori

La touche «favori» permet l'accès direct à une fonction prédéfinie et peut être configurée selon les besoins de l'utilisateur.

Pour attribuer une fonction à la touche «favori», effectuer une pression longue (>2s) sur , puis sélectionner la fonction souhaitée :

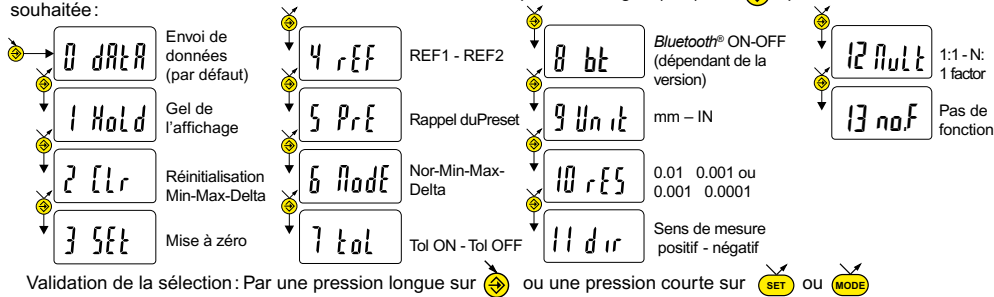

Remarque :

L'attribution de la fonction peut également se faire par RS 232, avec la commande <FCT + No. de fonction> (FCT 0..9 A..F)

exemple : Changement d'unité = <FCT9>, inverser la direction de mesure = <FCTB>

8. Extinction

Le comparateur se met automatiquement en stand-by après 10 minutes de non utilisation, sauf si le mode d'extinction automatique est désactivé (voir chap.4 fonctions avancées).

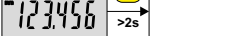

F Vous pouvez forcer le mode stand-by, par pression longue (>2s) sur  : 

En mode stand-by, la valeur d'origine est conservée par le capteur (mode SIS), et l'instrument redémarre automatiquement par un mouvement de la touche de mesure ainsi que par commande RS, ou par pression sur un bouton.

Il est possible d'éteindre complètement l'instrument pour une longue période de non utilisation, mais cela nécessitera une remise à zéro à l'enclenchement (perte de l'origine):

- Effectuer une pression longue (>4s) sur  : 

9. Réinitialisation de l'instrument

A tout moment, il est possible de restaurer les réglages initiaux de l'instrument, par une pression longue (>4s) simultanée sur  et  jusqu'à l'affichage du message *rESt*.

10. Personnalisation de l'instrument

Il est possible de personnaliser l'accès aux fonctions de votre instrument, pour plus d'information voir site-web du fabricant (nécessite une connexion de votre instrument, via un câble Proximity ou Power RS / USB, ou *Bluetooth*[®]).

Possibilités :

- Désactiver ou activer les fonctions souhaitées.
- Modifier l'accès aux fonctions avancées (mise en accès direct).

F

11. Connexion de l'instrument

L'instrument peut être connecté à un périphérique, via un câble Proximity (RS ou USB), ou Power-RS (Power-USB) ou *Bluetooth*[®]. Voir en page 2 pour la connexion des câbles.

Possibilité de transmettre les valeurs mesurées, et piloter l'instrument à l'aide de rétro-commandes prédéfinies (liste des commandes principales, voir chap.12).

Remarque :

- En mode Tolérance, les indicateurs lumineux des limites de tolérances ne restent allumés que quelques secondes lorsque la mesure est stabilisée.
- Par contre, ils resteront allumés en permanence si l'instrument est connecté et alimenté par le Power RS (USB).

12. Liste des commandes principales

Sélection et configuration

| | |
|-----------------------------|--|
| CHA+ / CHA- | Changement direction de mesure |
| FCT0 ...9...A...F | Attribution fonction «favori» |
| MM / IN | Changement unité de mesure |
| KEY0 / KEY1 | Active / désactive le blocage clavier |
| MUL [+/-]xxx.xxxx | Modification facteur de multiplication |
| PRE [+/-]xxx.xxx | Modification valeur de preset |
| REF1 / REF2 | Changement de la référence active |
| STO1 / STO0 | Active / désactive le HOLD |
| TOL1 / TOL0 | Active / désactive les tolérances |
| ECO1 / ECO0 | Active / désactive le mode économique |
| LCAL dd.mm.yy | Modifie date dernière calibration |
| NCAL dd.mm.yy | Modifie date prochaine calibration |
| NUM x...x (jusqu'à 20 car.) | Modifie le numéro de l'instrument |
| TOL +/-xxx.xxx +/-yyy.yyy | Introduction limites de tolérances |
| MIN / MAX / DEL / NOR | Sélection mode MIN, MAX, Delta, Normal |
| CLE | Réinitialisation du MIN, MAX ou Delta |
| UNI1 / UNIO | Active / désactive le changement d'unité |
| OUT1 / OUT0 | Active / désact. transmission données en continu |
| PRE ON / PRE OFF | Active / désact. la fonction Preset |
| PRE | Rappel du Preset |
| SET | Mise à zéro |
| RES1 / RES2 / RES3 | Changement résolution |

SBY xx xx nombre de minutes avant stand-by

BT0/BT1 Active / désactive le mode *Bluetooth*[®]
BTRST Réinitialisation de l'appairage

Interrogation

| | |
|-------|---|
| CHA? | Direction de mesure? |
| FCT? | Fonction «favori» active? |
| UNI? | Unité de mesure active? |
| KEY? | Blocage clavier? |
| MUL? | Facteur de multiplication? |
| PRE? | Valeur de preset? |
| REF? | Référence active? |
| STO? | Etat fonction HOLD? |
| TOL? | Valeur des limites de tol actuelles? |
| ECO? | Mode économique courant |
| LCAL? | Date dernière calibration? |
| NCAL? | Date prochaine calibration? |
| NUM? | Numéro de l'instrument? |
| ? | Valeur actuelle? (mode Tol, valeur suivie de <=>) |
| MOD? | Mode actif (MIN, MAX, Delta ou Normal)? |
| SET? | Paramètres principaux de l'instrument? |
| ID? | Code d'identification de l'instrument?OUT1 / |

Fonctions de maintenance

| | |
|------|---|
| BAT? | Etat pile (BAT1=Ok, BAT0=pile faible) |
| OFF | Extinct. complète (réveil par bouton ou RS) |
| RST | Réinitialisation de l'instrument |
| SBY | Mise en Stand by de l'instrument (SIS) |
| VER? | Version et date du firmware |

MAC? Adresse MAC du module *Bluetooth*[®]

13. Spécifications

| | | | | | | |
|-------------------------------------|--|------------|-----------|----------|----------|------------|
| Etendue de mesure : | 12.5mm | 25mm | 50mm | 100mm | 150mm | |
| Erreur max (résolution 10µm) : | 10µm | 10µm | 20µm | 20µm | 20µm | (±1 digit) |
| Erreur max (résolution 1µm) : | 3µm | 4µm | 5µm | 6µm | 10µm | |
| Erreur max (résolution 0.1µm) : | 1.2µm | 1.6µm | --- | --- | --- | |
| Répétabilité : | 2µm 0.3µm (échelle 0.0001mm) | | | | | |
| Poids : | 119g | 123g | 161g | 208g | 265g | |
| Force de mesure (standard) : | 0.65-0.9N | 0.65-1.15N | 1.25-2.7N | 1.6-3.5N | 2.2-5.7N | |
| Vitesse max. de déplacement : | 1.7m/s | | | | | |
| Nbre de mesure par seconde : | jusqu'à 10 mes/s mode MIN/MAX: jusqu'à 20 mes/s | | | | | |
| Unité de mesure : | métrique/anglaise (Inch) | | | | | |
| Preset maximum (résolution 10µm) : | ±9999.99 mm / ±399.9995 IN | | | | | |
| Preset maximum (résolution 1µm) : | ±999.999 mm / ±39.99995 IN | | | | | |
| Preset maximum (résolution 0.1µm) : | ±99.9999 mm / ±3.999995 IN | | | | | |
| Système de mesure : | Sylvac inductive system (breveté) | | | | | |
| Alimentation : | 1 batterie lithium 3V, type CR2032, capacité 220mAh | | | | | |
| Autonomie moyenne : | 8'000 heures (avec <i>Bluetooth</i> ® enclenché, voir chapitre 6.1) | | | | | |
| Sortie de données : | compatible RS232 / <i>Bluetooth</i> ® 4.0 (voir chapitre 6) | | | | | |
| Température de travail (stockage) : | +5 à +40 C (-10 à +60 C) | | | | | |
| Compatibilité électromagnétique : | selon EN 61326-1 | | | | | |
| Spécification IP (selon IEC60529) : | IP 54 / IP 67 (dépend de la version) | | | | | |
| Fixation et encombrement : | fixation Ø8h6 (3/8"), touche de mesure interchangeable M2.5 (4-48-UNF) (selon DIN 878) | | | | | |

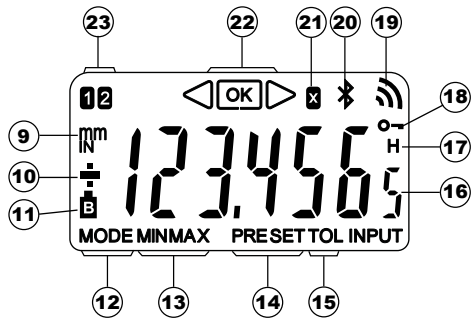
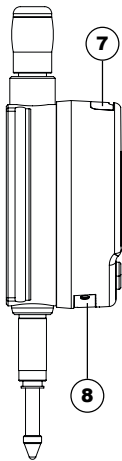
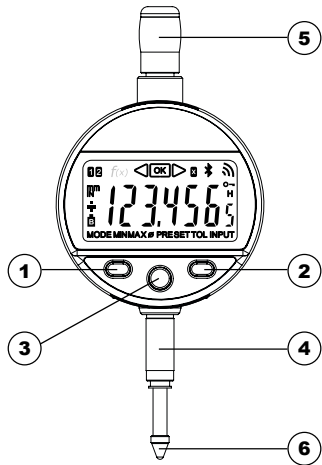

F

D

Beschreibung

1. MODE-Taste
2. SET-Taste
3. Favoriten-Taste
4. Einspannschaft Ø8 oder 3/8"
5. Abhebekapsel
6. Kugeltaster Ø2/M2.5 oder 4-48-UNF
7. Buchse für Proximity Kabel
8. Batterieeinschub oder Netzkabelbuchse
9. Masseinheit (mm/INCH)
10. +/- Anzeige
11. Batterie schwach
12. Anzeige des Menüs Mode
13. MIN/MAX/DELTA-Modus
14. Preset-Modus
15. Toleranz-Modus
16. 7- stellige Anzeige
17. Festhalten des Messwerts
18. Tastatursperre
19. Datenübertragung
20. *Bluetooth*®-Verbindung (versionsabhängig)
21. Multiplikationsfaktor
22. Toleranzanzeiger
23. Aktive Referenz

1. Funktionalitäten des Instruments:

-  Das Instrument verfügt über zwei Betriebsarten: Basisfunktionen (mit direktem Zugang) und fortgeschrittene Funktionen. Neben den Konfigurationsfunktionen hat man Zugriff auf 2 Arbeitsreferenzen, die Modi MIN, MAX und DELTA (TIR), auf die Toleranzanzeige oder auf die Eingabe eines anderen Multiplikationsfaktors als 1:1. (siehe Kap. 3 und 4).
-  Mit der Taste „Favoriten“ kann man der am häufigsten verwendeten Funktion einen direkten Zugriff zuzuweisen (siehe Kap. 7).
-  Ermöglicht die Zuweisung eines Presetwertes, die Reinitialisierung der Modi MIN/MAX, die Quittierung einer Auswahl und das Ausschalten des Instruments. Der SIS-Modus ermöglicht standardmässig das automatische Ausschalten ohne Verlust des Referenzwertes (siehe Kap. 8).

- Personalisierung der Funktionen

Es ist möglich, einige Funktionen des Instruments über R232 zu aktivieren oder zu deaktivieren (siehe Kap.10).

- Parameter für Datenübertragung

4800Bds, 7 Bits, gerade Parität, 2 Stop Bits.

2. Starten

Eine Taste drücken.

Zur *Bluetooth*[®]-Verbindung (siehe Kap. 6).

3. Grundfunktionen

Eine kurze Betätigung von  ermöglicht einen direkten Zugriff auf die Grundfunktionen:

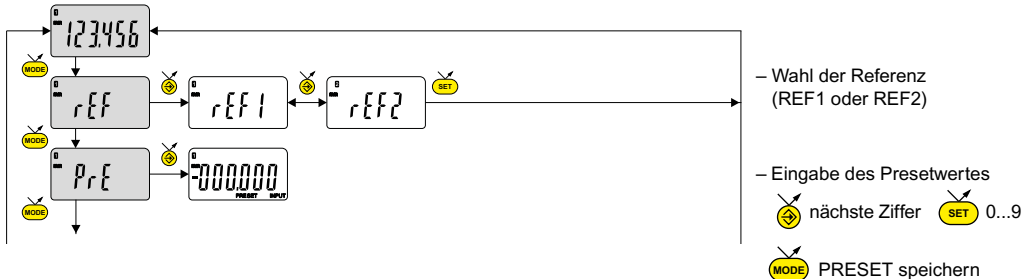

Anmerkung:

- Es ist möglich, jeder der beiden Referenzen einen unterschiedlichen Presetwert zuzuordnen. Ebenso kann man den Referenzen 1 und 2 unterschiedliche Toleranzgrenzen zuordnen.

..... Fortsetzung

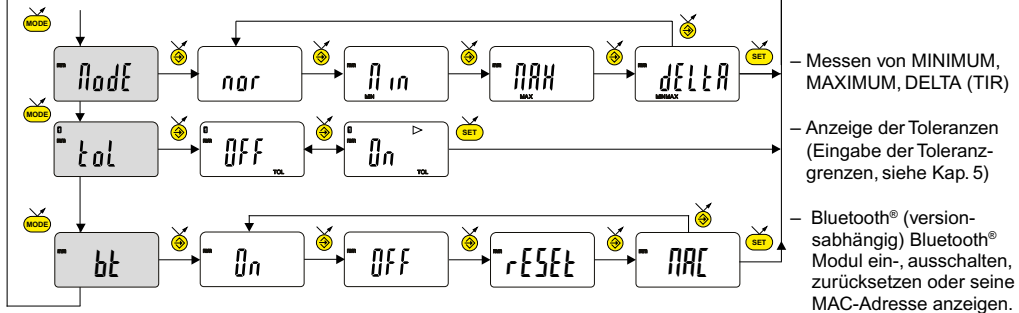

D

..... Fortsetzung

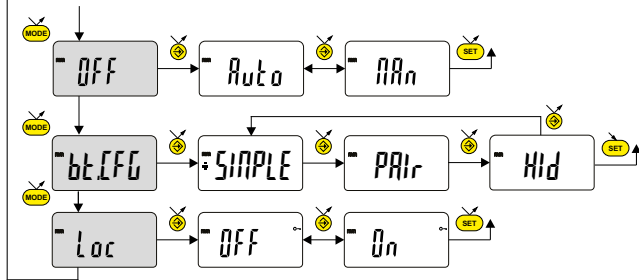



- Stand-by-Modus
PAN = deaktiviert, Auto = aktiv (standardmässig nach 10 Min.)

Auswahl des Bluetooth-Profiles

- (versionsabhängig).
(Siehe Kap. 6 für weitere Informationen).
Das + Symbol markiert die aktuelle Auswahl.

- Tastatursperre

Nur die Favoriten-Taste  bleibt aktiv (um die Tastatursperre aufzuheben,  5 s lang drücken).

D

5. Eingabe der Toleranzgrenzen

Um die Toleranzgrenzen einzugeben oder zu ändern, Betriebsart t_{ol} wählen und dann kurz auf **MODE** drücken.

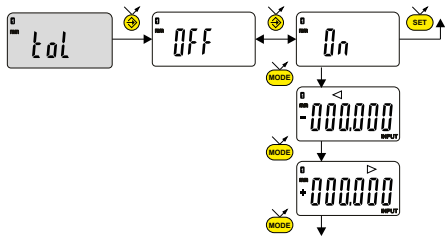

– Die untere Toleranzgrenze eingeben ◀

– Die obere Toleranzgrenze eingeben ▶

↻ nächste Ziffer SET 0...9 MODE TOL speichern



Anmerkung:

- Im Fall einer Messung der inneren Abmasse kann man die Anzeiger (rot und gelb) kreuzen, indem man die Eingabereihenfolge der Toleranzgrenzen umkehrt (untere Grenze > obere Grenze).
- Es ist möglich, verschiedene Toleranzwerte bei REF1 und REF2 einzugeben.





- Es ist auch möglich, die Toleranzwerte anzuzeigen, wenn das Instrument in der Betriebsart MIN, MAX oder DELTA (TIR) arbeitet.
- Falls keine Toleranzgrenzen festgelegt wurden, stellt das Instrument die Toleranzgrenzanzeige  dar, aber ohne die Leuchtmelder (rot – grün – gelb) zu aktivieren.“

6. *Bluetooth*[®]-Konfiguration (je nach Modell)

Der Verbindungsaufbau ist ganz einfach und wird in 3 Zuständen angezeigt:

- | | | |
|------------|---|------------------------------------|
| Kein |  | Symbol keine Verbindung |
| Blinkendes |  | Symbolbereit zur Verbindung |
| Stehendes |  | SymbolVerbindung hergestellt |

Zur Konfiguration des *Bluetooth*[®]-Moduls stehen die folgenden Optionen zur Verfügung:

- | | |
|---|---|
|  | Aktiviert das <i>Bluetooth</i> [®] -Modul (Instrument kann gefunden werden). |
|  | Deaktiviert das <i>Bluetooth</i> [®] -Modul (aktive Verbindung wird getrennt). |
|  | Hebt die <i>Bluetooth</i> [®] -Kopplung auf. |
|  | Zeigt die MAC (Media Access Control) -Adresse an. |

Drei *Bluetooth*[®]-Profile stehen zur Auswahl:

SIMPLE

Profil ohne Kopplung.

PAIR

Profil mit Kopplung und Verschlüsselung.

HID

Virtuelle Tastatur (Kompatibel mit aktuellen Geräten ohne Installation eines Treibers).

Anmerkung:

- Beim Wechsel des Profils wird die Bluetooth-Kopplung aufgehoben.

Verbindungsaufbau :

- 1 Stellen Sie sicher, dass die *Bluetooth*[®] Anwendung und das Gerät kompatibel und aktiv sind (PC, Messeinheit).
- 2 Schalten Sie das Instrument ein. Die *Bluetooth*[®]-Funktion ist standardmässig aktiviert und das Instrument kann verbunden werden (Verbindung wird gesucht).
- 3 Wurde keine Verbindung hergestellt während das Instrument sichtbar war, aktivieren Sie *Bluetooth*[®] erneut über das Menü *bt / On*.
- 4 Das Gerät ist bereit zum Senden (Verbindung hergestellt).

Kopplung :

Die Kopplung des Instruments mit dem Master erfolgt automatisch bei der ersten Verbindung. Um das Instrument mit einem neuen Master zu verbinden (neue Kopplung), muss die Kopplung über das Menü *bt / rESET* gelöscht werden.



6.1 Technische Daten der *Bluetooth*[®]-Funktion



| | |
|-----------------------|--|
| Frequenzband | 2.4GHz (2.402 - 2.480GHz) |
| Modulation | GFSK (Gaussian Frequency Shift Keying) |
| Max. Ausgangsleistung | Klasse 3: 1mW (0dBm) |
| Reichweite | Im Freien: bis 15 m Industrieumgebung: 1-5 m |
| Autonomie | Continuous : bis zu 2 Monaten (Immer verbunden mit 4 Werten /sek). Saver : bis zu 5 Monaten (Das Gerät sendet die Werte nur wenn die Position geändert hat). Blind/Push : bis zu 7 Monaten (Der Wert wird von dem Gerät gesendet (Taste) oder vom Computer angefordert). |

Weitere Spezifikationen auf der Website des Herstellers.

7. Favoriten-Taste

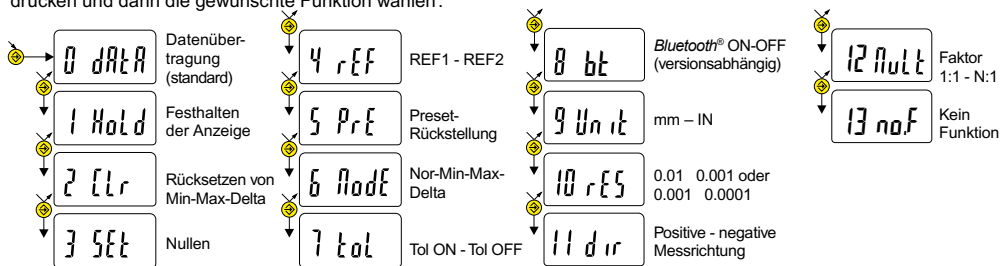
Die „Favoriten-Taste“ ermöglicht den direkten Zugriff auf eine zuvor bestimmte Funktion und kann entsprechend der Bedürfnisse des Nutzers konfiguriert werden. Um der „Favoriten-Taste“ eine Funktion zuzuordnen, muss man lange auf  drücken und dann die gewünschte Funktion wählen:



Bestätigung der Auswahl: Durch langes Drücken von  oder kurzes Drücken von  oder 

Anmerkung:

- Die Zuordnung der Funktion kann auch durch RS 232 erfolgen, mit dem Befehl <FCT + Funktions-Nr> (FCT 0..9 A..F)
Beispiel: Masseinheit ändern = <FCT9>, Messrichtung wechseln = <FCTB>

8. Ausschalten

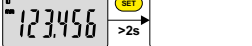

Die Messuhr stellt sich nach 10 Minuten Nichtgebrauch automatisch auf Stand-By, ausser, wenn der Stand-by-Modus deaktiviert ist (siehe Kap. 4, fortgeschrittene Funktionen).

Stand-By-Funktion durch langes Betätigen (>2s) von  erzwingen. 



Im Stand-By-Modus wird der Referenzwert vom Sensor (SIS Modus) beibehalten und das Instrument startet automatisch mit einer Bewegung des Messeinsatzes sowie durch einen RS232 Steuerbefehl oder durch einen Tastendruck.

D

Es ist möglich, das Instrument für eine lange Zeit des Nichtgebrauchs vollständig auszuschalten, aber das erfordert eine Rückstellung beim Einschalten (Verlust des Referenzwertes).

- Lange (>4s) Drücken auf  : 

9. Rücksetzen des Instruments

Durch ein langes (>4s), gleichzeitiges Drücken auf  und , bis das Display *reset* anzeigt, können die Standardeinstellungen des Instruments wiederhergestellt werden.

10. Personalisierung des Instruments

Der Zugriff auf die Funktionen Ihres Instruments kann personalisiert werden.

Weitere Informationen finden Sie auf der Webseite des Herstellers (erfordert den Anschluss Ihres Instruments mit einem Proximity-Kabel oder RS / USB Power, oder *Bluetooth*[®]).

Möglichkeiten:

- Deaktivierung oder Aktivierung der erwünschten Funktionen
- Änderung des Zugriffs auf die fortgeschrittenen Funktionen (Schaffung eines direkten Zugriffs)

11. Anschluss des Instruments

Das Instrument kann mit einem Proximity-Kabel (RS oder USB) oder Power-RS (Power-USB) oder über eine *Bluetooth*[®]-Verbindung an ein Peripheriegerät angeschlossen werden. Informationen zum Kabelanschluss finden Sie auf Seite 2.

Messwerte können übertragen und das Instrument durch Befehle gesteuert werden. Liste der wesentlichen Steuerbefehle, siehe Kap. 12.

Anmerkung :

- Im Toleranzmodus leuchten die Leuchtanzeigen der Toleranzgrenzen nur einige Sekunden, wenn die Messung stabilisiert ist. - Sie bleiben jedoch ständig an, falls das Instrument durch das Power-RS- (USB-) Kabel gespeist wird.

12. Liste der wesentlichen Steuerbefehle

Auswahl und Konfiguration

| | |
|----------------------------|---|
| CHA+ / CHA- | Wechsel der Messrichtung |
| FCT0 ...9...A...F | Zuordnung der Funktion „Favorit“ |
| MM / IN | Wechsel der Masseinheit |
| KEY0 / KEY1 | Aktiviert / Deaktiviert die Tastatursperre |
| MUL [+/-]xxx.xxxx | Änderung des Multiplikationsfaktors |
| PRE [+/-]xxx.xxx | Änderung des Presetwertes |
| REF1 / REF2 | Wechsel der aktiven Referenz |
| STO1 / STO0 | Aktiviert / Deaktiviert den HOLD |
| TOL1 / TOL0 | Aktiviert / Deaktiviert die Toleranzen |
| ECO1 / ECO0 | Aktiviert / Deaktiviert ECO Modus |
| LCAL dd.mm.yy | Ändert das Datum der letzten Kalibrierung |
| NCAL dd.mm.yy | Ändert das Datum der nächsten Kalibrierung |
| NUM x...x (bis zu 20 Kar.) | Ändert der Instrumentnummer |
| TOL +/-xxx.xxx +/-yyy.yyy | Eingabe Toleranzgrenzen |
| MIN / MAX / DEL / NOR | Auswahl des Modus MIN, MAX, Delta, Normal |
| CLE | Rücksetzen von Min, Max oder Delta |
| UNI1 / UNIO | Aktiviert / Deaktiviert den Einheitswechsel |
| OUT1 / OUT0 | Aktiviert / Deaktiviert die kontinuierliche Datenübertragung |
| PRE ON / PRE OFF | Aktiviert / Deaktiviert die Presetfunktion |
| PRE | Preset-Rückstellung |
| SET | Nullen |
| RES1 / RES2 / RES3 | Ändern des Ziffernschrittwerts |
| SBY xx | Ändert die Dauer (xx Minuten) bis zum Stand-by |
| BT0/BT1 | Aktiviert / deaktiviert die <i>Bluetooth</i> [®] -Funktion |
| BTRST | <i>Bluetooth</i> [®] - Kopplung aufheben |

Abfragen

| | |
|-------|---|
| CHA? | Messrichtung? |
| FCT? | Funktion „Favorit“ aktiv? |
| UNI? | Masseinheit aktiv |
| KEY? | Tastatursperre? |
| MUL? | Multiplikationsfaktor? |
| PRE? | Presetwert? |
| REF? | Aktive Referenz? |
| STO? | HOLD Funktionsstatus? |
| TOL? | Wert der aktuellen Tol.-Grenzen? |
| ECO? | Actueller ECO Modus |
| LCAL? | Datum der letzten Kalibrierung? |
| NCAL? | Datum der nächsten Kalibrierung? |
| NUM? | Instrumentnummer? |
| ? | Actueller Wert (Tol.-Modus, Wert gefolgt von <=>) |
| MOD? | Aktiver Modus (MIN, MAX, Delta oder Normal)? |
| SET? | Hauptparameter des Instruments? |
| ID? | Identifizierungscode des Instruments? |

Wartungsfunktionen

| | |
|------|---|
| BAT? | Batteriestatus (BAT1=Ok, BAT0=Batterie schwach) |
| OFF | Vollständ.Ausschalten (Einschalten mit Taste oder RS) |
| RST | Rücksetzen des Instruments |
| SBY | Versetzt das Instrument in den Stand-by-Modus |
| VER? | Revision und Datum der Firmware |
| MAC? | MAC-Adresse des <i>Bluetooth</i> [®] -Moduls |

13. Spezifizierungen

| | | | | | | |
|-------------------------------------|--|------------|---------------------------------------|----------|----------|------------|
| Messbereich: | 12.5mm | 25mm | 50mm | 100mm | 150mm | |
| Fehlergrenze (Auflösung 10µm): | 10µm | 10µm | 20µm | 20µm | 20µm | (±1 digit) |
| Fehlergrenze (Auflösung 1µm): | 3µm | 4µm | 5µm | 6µm | 10µm | |
| Fehlergrenze (Auflösung 0.1µm): | 1.2µm | 1.6µm | --- | --- | --- | |
| Wiederholbarkeit: | 2µm 0.3µm (Stufe 0.0001mm) | | | | | |
| Gewicht: | 119g | 123g | 161g | 208g | 265g | |
| Messkraft (Standard): | 0.65-0.9N | 0.65-1.15N | 1.25-2.7N | 1.6-3.5N | 2.2-5.7N | |
| Maximale Bewegungsgeschwindigkeit: | 1.7m/s | | | | | |
| Anzahl der Messungen pro Sekunde: | bis zu 10 Mess/s | | Betriebsart MIN/MAX: bis zu 20 Mess/s | | | |
| Masseinheit: | mm / Inch | | | | | |
| Maximum Preset (Auflösung 10µm): | ±9999.99 mm / ±399.9995 IN | | | | | |
| Maximum Preset (Auflösung 1µm): | ±999.999 mm / ±39.99995 IN | | | | | |
| Maximum Preset (Auflösung 0.1µm): | ±99.9999 mm / ±3.999995 IN | | | | | |
| Messsystem: | Sylvac inductive system (patentiert) | | | | | |
| Versorgung: | 1 x 3 V Lithiumbatterie, Typ CR2032, Kapazität 220 mAh | | | | | |
| Durchschnittliche Autonomie: | 8.000 Stunden (mit <i>Bluetooth</i> ® aktiviert, siehe Kap. 6.1) | | | | | |
| Datenausgang: | RS232 kompatibel / <i>Bluetooth</i> ® 4.0 (siehe Kap. 6) | | | | | |
| Arbeitstemperatur (Lagerung): | +5 bis +40 C (-10 bis +60 C) | | | | | |
| Elektromagnetische Verträglichkeit: | gemäss EN 61326-1 | | | | | |
| IP Spezifikation (gemäss IEC60529): | IP 54 / IP 67 (je nach Modell) | | | | | |
| Befestigung und Platzbedarf: | Ø8h6 (3/8") Befestigung, austauschbarer M2.5 (4-48-UNF) Messeinsatz (gemäss DIN 878) | | | | | |

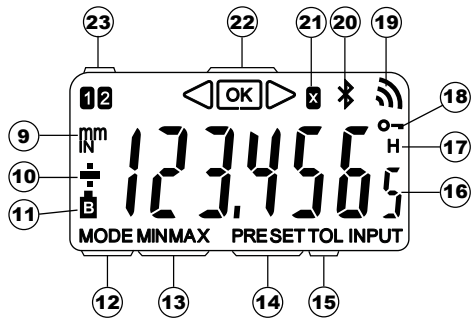
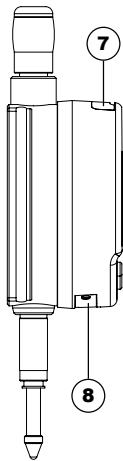
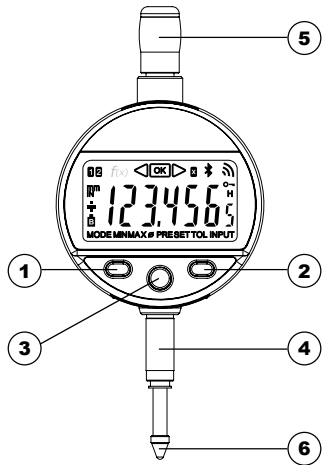

D



Description

1. Pulsante Modalità
2. Pulsante Impostazione
3. Pulsante « Preferiti »
4. Albero di fissaggio Ø8 o 3/8"
5. Elemento di sollevamento
6. Tasto a sfera Ø2/M2.5 o 4-48-UNF
7. Alloggiamento per cavo di Proximity
8. Alloggiamento batteria o cavo di alimentazione
9. Unità di misura (mm/INCH)
10. Indicatori +/-
11. Batteria scarica
12. Indicazione del menu Modalità
13. Modalità MIN/MAX/DELTA
14. Modalità Preset
15. Modalità Tolleranze
16. Visualizzazione a 7- cifre
17. Congelamento del valore di misura
18. Blocco pulsant
19. Invio dati
20. Connessione *Bluetooth*[®] (a seconda della versione)
21. Fattore di moltiplicazione
22. Indicatori di tolleranze
23. Riferimento attivo

1. Funzionalità dello strumento

-  Lo strumento dispone di 2 modalità operative: funzioni base (con accesso diretto) e funzioni avanzate. Oltre alle funzioni di configurazione, si ha accesso a 2 riferimenti di lavoro, alla modalità MIN, MAX e DELTA (TIR), alla visualizzazione delle tolleranze o all'inserimento di un fattore di moltiplicazione diverso da 1:1. (consultare i capitoli 3 e 4).
-  Il tasto «preferito» permette di attribuire un accesso diretto alla funzione utilizzata maggiormente (consultare il capitolo 7).
-  Permette di attribuire un valore di Preset, di reinizializzare la modalità MIN/MAX, di confermare una selezione e di gestire lo spegnimento dello strumento. Per impostazione predefinita, la modalità SIS permette lo spegnimento automatico senza perdita dell'origine (consultare il capitolo 8).
- **Personalizzazione delle funzioni**
È possibile attivare o disattivare determinate funzioni dello strumento mediante RS232 (consultare il capitolo 10)
- **Parametri di trasmissione dati**
4800Bds, 7 bit, parità, 2 stop bit.

2. Avvio

Premere un pulsante.
Per una connessione *Bluetooth*[®] (vedere il capitolo 6).

3. Funzione di base

Ogni breve pressione su  permette l'accesso diretto alle funzioni base :

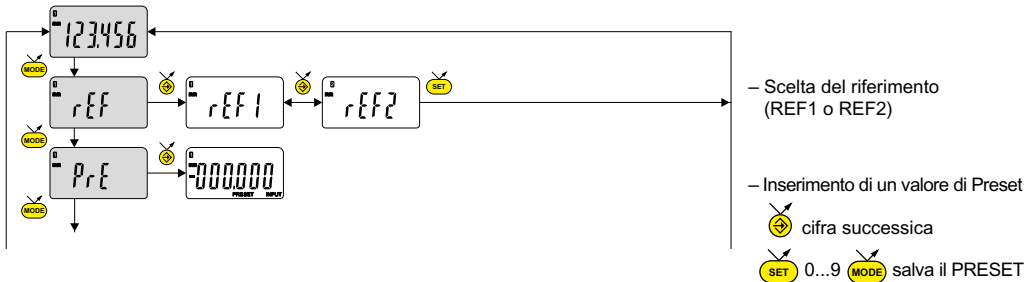

Nota:

- è possibile assegnare un valore di preset differente a ognuno dei 2 riferimenti. Analogamente è possibile assegnare dei limiti di tolleranza diversi sui riferimenti 1 e 2.

..... segue

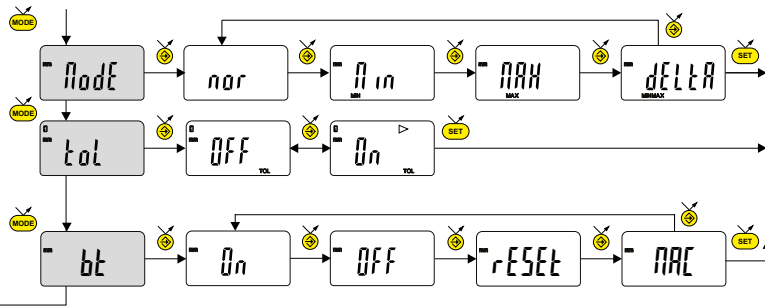

- Misura del MINIMUM, MAXIMUM, DELTA (TIR)

- Visualizzazione delle tolleranze (inserimento dei limiti di tolleranza, consultare il capitolo 5)

- Bluetooth® (a seconda della versione). Attivare / disattivare, reimpostazione del modulo Bluetooth® o visualizzazione dell'indirizzo MAC.

4. Funzioni avanzate

Una pressione lunga (>2s) su **MODE** permette di accedere alle funzioni avanzate. Successivamente, ogni breve pressione su

MODE accede alla funzione desiderata:

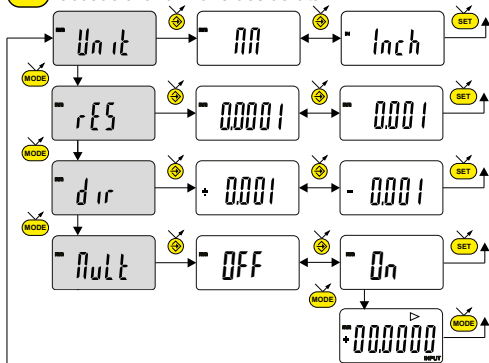

– Selezione dell'unità (mm o Inch)

– Scelta della risoluzione 0.01 / 0.001 o 0.001 / 0.0001 (a seconda della versione)

– Scelta della direzione di misura (senso positivo o negativo)

– Fattore di moltiplicazione

Attivare o disattivare il fattore di moltiplicazione (il valore può essere modificato $\overline{0n}$ si preme un pulsante **MODE**).

– Inserimento di un Fattore di moltiplicazione

cifra successiva 0....9 salva MULT

..... segue

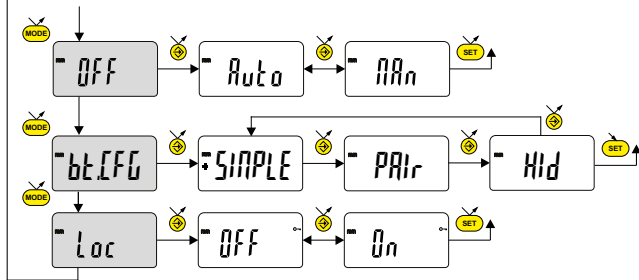



- Modalità di spegnimento automatico
Off = disattiva, *Auto* = attiva (dopo 10 min. per difetto).

Selezione del profilo *Bluetooth®*

- (a seconda della versione).
(vedere il cap. 6 per ulteriori dettagli).
Il simbolo + indica il profilo attivo.

- Blocco tastiera

Solo il tasto preferito  rimane attivo (per disattivare il blocco tastiera, premere  per 5 s.).

5. Inserimento dei limiti di tolleranza

Per inserire o modificare i limiti di tolleranza, occorre selezionare la modalità t_{ol} $0n$, seguita da una breve pressione

su :

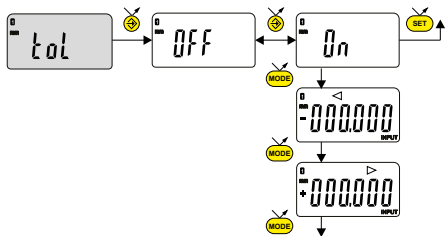

– Inserire il limite di tolleranza inferiore 

– Inserire il limite di tolleranza superiore 

 cifra successiva  0...9  salva il TOL

Nota:

- In caso di misura di dimensioni interne, è possibile incrociare le spie (rossa e gialla) invertendo l'ordine d'inserimento dei limiti di tolleranza (limite inferiore > limite superiore).
- È possibile inserire dei limiti di tolleranza diversi sui REF1 e REF2.

- È anche possibile visualizzare i limiti di tolleranza mentre lo strumento è in modalità MIN, MAX o DELTA (TIR)
- Se l'utente non ha definito nessun limiti di tolleranza, lo strumento visualizza gli indicatori dei limiti di tolleranze ◀  ▶ ma senza attivare le spie (rosso – verde - giallo)

6. Configurazione *Bluetooth*[®] (a seconda del modello)

La procedura la connessione è stata pensata per essere semplice ed è indicata dai 3 seguenti stati:

- Simbolo  spentomodalità scollegata
- Simbolo  lampeggiantemodalità scoperta
- Simbolo  accesomodalità collegata

È possibile selezionare le seguenti opzioni per controllare il modulo *Bluetooth*[®].

- On** Ativarre il modulo *Bluetooth*[®] (avviare la modalità di ricerca).
- OFF** Disabilita il modulo *Bluetooth*[®] (disattiva la connessione attiva).
- rESEt** Cancellare le informazioni di accoppiamento.
- MAC** Visualizza l'indirizzo MAC (Media Access Control).

Sono disponibili tre profili *Bluetooth*[®].

SIMPLE Profilo non accoppiato (per impostazione predefinita).

PAIR Profilo accoppiato e sicuro.

HID Modalità tastiera virtuale (compatibili con apparecchiature più recenti senza l'installazione del driver).

Nota:

- Le informazioni *Bluetooth*[®] vengono cancellate quando il profilo viene modificato.

Connessione :

- 1 Assicurarsi che l'applicazione e il l'apparecchio *Bluetooth*[®] compatibili siano attivi (PC, unità di misura).
- 2 Avviare lo strumento. Come impostazione predefinita il modulo *Bluetooth*[®] è attivo e lo strumento è collegabile (modalità scoperta).
- 3 Da quando lo strumento è rilevato il collegamento è automatico. Se la connessione non è stata stabilita mentre lo strumento è in modalità di rilevazione, riattivare il modulo *Bluetooth*[®] mediante il menu *bt / On*.
- 4 Lo strumento è pronto alla trasmissione (modalità collegata).

Accoppiamento :

L'accoppiamento dello strumento con la periferica avviene automaticamente all'avvio.

Per collegare uno strumento a una nuova periferica (nuovo accoppiamento) è necessario cancellare le informazioni di accoppiamento mediante il menu *bt / reset*.

6.1 Specifiche *Bluetooth*[®]



| | |
|---------------------------|--|
| Banda di frequenza | 2.4GHz (2.402 - 2.480GHz) |
| Modulazione | GFSK (Gaussian Frequency Shift Keying) |
| Potenza massima in uscita | Classe 3: 1mW (0dBm) |
| Portata | Spazio aperto: fino a 15 m Ambiente industriale: 1-5m |
| Autonomia | Continuous : fino a 2 mesi (sempre connessi con i 4 valori / sec). Saver : fino a 5 mesi (Lo strumento invia valore solo quando la posizione è cambiata). Blind/Push : fino a 7 mesi (valore viene inviato dal (pulsante strumento) o richiesto dal computer). |

Altre specifiche sul sito del produttore.

7. Tasto preferito

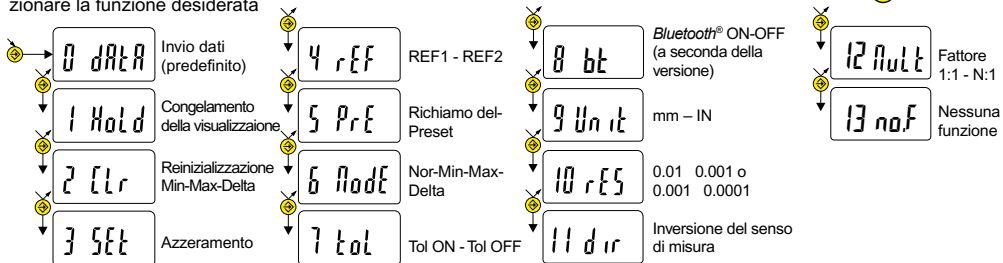
Il tasto «preferito» permette di accedere direttamente a una funzione predefinita e può essere configurato secondo le esigenze dell'utente. Per assegnare una funzione al tasto «preferito», applicare una pressione lunga su , quindi selezionare la funzione desiderata



Conferma della selezione: mediante pressione lunga su  o una breve pressione su  o 

Nota:

- la funzione può essere assegnata anche mediante RS 232, con il comando <FCT + No. di funzione> (FCT 0..9 A..F)
esempio: Modifica di unità di misura = <FCT9>, direzione inversa di misura = <FCTB>

8. Spegnimento

Il comparatore va automaticamente in stand-by dopo 10 minuti di inattività, tranne se la Modalità di spegnimento automatico è disattivata (consultare il capitolo 4 funzioni avanzate)

È possibile forzare la modalità stand-by, con una pressione lunga (>2s) su  :

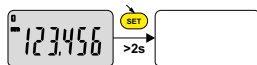



In modalità stand-by, il valore di origine è memorizzato dal sensore (modalità SIS), e lo strumento si riavvia automaticamente con un movimento del tasto di misura mediante il comando RS, o premere un pulsante.

È possibile spegnere completamente lo strumento per un lungo periodo di non utilizzo, ma sarà necessario un azzeramento al momento del collegamento (perdita dell'origine):

- Applicare una pressione lunga (>4s) su  :



9. Reinizializzazione dello strumento

In qualsiasi momento è possibile ripristinare le impostazioni originali dello strumento con una pressione lunga (>4s) contemporanea su  e  fino a visualizzare il messaggio *reset*.

10. Personalizzazione dello strumento

È possibile personalizzare l'accesso alle funzioni dello strumento mediante il software gratuito, il sito web del produttore (lo strumento deve essere connesso, con un cavo PROXIMITY o di alimentazione RS / USB, o *Bluetooth*[®]).

Possibilità:

- Disattivare o attivare le funzioni desiderate
- Modificare l'accesso alle funzioni avanzate (messa in accesso diretto)

11. Connessione dello strumento

Lo strumento può essere connesso a una periferica mediante un cavo Proximity (RS o USB), o di POWER-RS e POWER-USB, o *Bluetooth*[®]. Vedere pagina 2 per il collegamento dei cavi.

È possibile trasmettere i valori misurati e comandare lo strumento con dei retro-comandi predefiniti (elenco dei comandi principali, consultare il capitolo 12)

Nota :

- In modalità Tolleranza, le spie dei limiti di tolleranza rimangono accese solo per pochi secondi mentre la misura si stabilizza. Resteranno accese in modo fisso se lo strumento è collegato e alimentato con il cavo POWER-RS e POWER- USB.

12. Elenco dei comandi principali

Selezione e configurazione

| | |
|----------------------------|---|
| CHA+ / CHA- | Modifica direzione di misura |
| FCT0 ...9...A...F | Assegnazione funzione «preferito» |
| MM / IN | Modifica unità di misura |
| KEY0 / KEY1 | Attiva / disattiva il blocco tastiera |
| MUL [+/-]xxx.xxx | Modifica fattore di moltiplicazione |
| PRE [+/-]xxx.xxx | Modifica valore di preset |
| REF1 / REF2 | Modifica del riferimento attivo |
| STO1 / STO0 | Attiva / disattiva HOLD |
| TOL1 / TOL0 | Attiva / disattiva le tolleranze |
| ECO1 / ECO0 | Attiva / disattiva la modalità economica |
| LCAL dd.mm.yy | Modifica data ultima calibratura |
| NCAL dd.mm.yy | Modifica data prossima calibratura |
| NUM x...x (fino a 20 car.) | Modifica il numero dello strumento |
| TOL +/-xxx.xxx +/-yyy.yy | Inserimento limiti di tol. attuali |
| MIN / MAX / DEL / NOR | Selezione modalità MIN, MAX, Delta, Normale |
| CLE | Reinizializzazione del MIN, MAX o Delta |
| UNI1 / UNIO | Attiva / disattiva il cambio di unità |
| OUT1 /OUT0 | Attiva / disatt. trasmissione dati continua |
| PRE ON / PRE OFF | Attiva / disatt. la funzione Preset |
| PRE | Richiamo del Preset |
| SET | Azzeramento |
| RES1 / RES2 / RES3 | Modifica risoluzione |
| SBY xx | xx numero di minuti prima dello Stand by |
| BT0/BT1 | Attiva / disattiva la modalità <i>Bluetooth</i> ® |
| BTRST | Reinizializzazione dell'accoppiamento |

Interrogazione

| | |
|---------------------------------|--|
| CHA? | Senso di misura? |
| FCT? | Funzione «preferito» attiva? |
| UNI? | Unità di misura attiva? |
| KEY? | Blocco tastiera? |
| MUL? | Fattore di moltiplicazione? |
| PRE? | Valore di preset? |
| REF? | Riferimento attivo? |
| STO? | Stato funzione HOLD? |
| TOL? | Valore dei limiti di tol. attuali? |
| ECO? | Attuale modalità economica? |
| LCAL? | Data ultima calibratura? |
| NCAL? | Data prossima calibratura? |
| NUM? | Numero dello strumento? |
| ? | Valore attuale (modalità Tol, valore seguito da <=>) |
| MOD? | Modalità attiva (MIN, MAX, Delta o Normale)? |
| SET? | Parametri principali dello strumento? |
| ID? | Codice d'identificazione dello strumento? |
| Funzioni di manutenzione | |
| BAT? | Stato batteria (BAT1=Ok, BAT0=batteria scarica) |
| OFF | Spegnim. completo (riattivazione mediante pulsante o RS) |
| RST | Reinizializzazione dello strumento |
| SBY | Messa in Stand by dello strumento (SIS) |
| VER? | Revisione e data del firmware |
| MAC? | Indirizzo MAC del modulo <i>Bluetooth</i> ® |

13. Specifiche

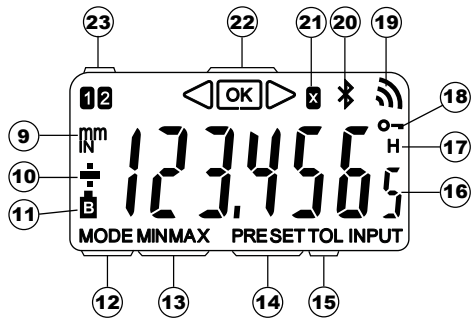
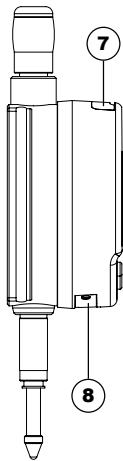
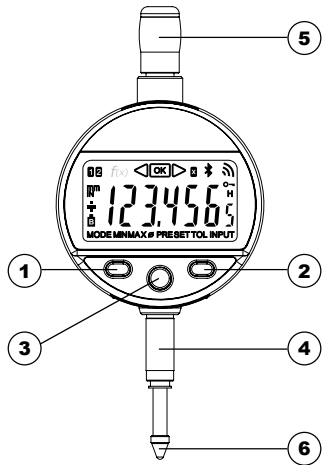

| | | | | | | |
|---|---|-------------|------------|------------|------------|------------------|
| Campo di misura: | 12.5mm | 25mm | 50mm | 100mm | 150mm | |
| Errore max (risoluzione 10 μ m): | 10 μ m | 10 μ m | 20 μ m | 20 μ m | 20 μ m | (± 1 digit) |
| Errore max (risoluzione 1 μ m): | 3 μ m | 4 μ m | 5 μ m | 6 μ m | 10 μ m | |
| Errore max (risoluzione 0.1 μ m): | 1.2 μ m | 1.6 μ m | --- | --- | --- | |
| Ripetibilità: | 2 μ m 0.3 μ m (risoluzione 0.0001mm) | | | | | |
| Peso: | 119g | 123g | 161g | 208g | 265g | |
| Forza di misura (standard): | 0.65-0.9N | 0.65-1.15N | 1.25-2.7N | 1.6-3.5N | 2.2-5.7N | |
| Velocità max. di spostamento: | 1.7m/s | | | | | |
| N. di misure al secondo: | fino a 10 mis/s modalità MIN/MAX: fino a 20 mis/s | | | | | |
| Unità di misura: | metrica/inglese (Inch) | | | | | |
| Preset massimo (risoluzione 10 μ m): | ± 9999.99 mm / ± 399.9995 IN | | | | | |
| Preset massimo (risoluzione 1 μ m): | ± 999.999 mm / ± 39.99995 IN | | | | | |
| Preset massimo (risoluzione 0,1 μ m): | ± 99.9999 mm / ± 3.999995 IN | | | | | |
| Sistema di misura: | Sistema Sylvac induttivo (brevettato) | | | | | |
| Alimentation: | 1 batteria al litio 3 V, tipo CR2032, capacità 220 mAh | | | | | |
| Autonomia media: | 8.000 ore (con <i>Bluetooth</i> [®] abilitato, cap. 6.1) | | | | | |
| Uscita dati: | compatibile RS232 / <i>Bluetooth</i> [®] 4.0 (cap. 6) | | | | | |
| Temperatura operativa (stoccaggio): | da +5 a +40 C (da -10 a +60 C) | | | | | |
| Compatibilità elettromagnetica: | secondo EN 61326-1 | | | | | |
| Specifica IP (secondo IEC60529): | IP 54 / IP 67 (in base al modello) | | | | | |
| Fissaggio e ingombro: | fissaggio $\varnothing 8h6$ (3/8"), tasto di misura intercambiabile M2.5 (4-48-UNF) (secondo DIN 878) | | | | | |



Description

1. Botón Modo
2. Botón Configuración
3. Botón « Favoritos »
4. Cañón de fijación Ø8 o 3/8"
5. Corona de elevación
6. Palpador de bola Ø2/M2.5 o 4-48-UNF
7. Alojamiento para cable Proximity
8. Alojamiento para batería o cable Power
9. Unidad de medida (mm/pulgadas)
10. Indicadores +/-
11. Batería baja
12. Indicación del menú Modo
13. Modo MIN/MAX/DELTA
14. Modo Preset
15. Modo Tolerancias
16. Visualización de 7 - dígitos
17. Congelación del valor de medición
18. Bloqueo del botón
19. Envío de datos
20. Conexión *Bluetooth*[®] (depende de la versión)
21. Factor de multiplicación
22. Indicadores de tolerancia
23. Referencia activa

1. Funcionalidades del equipo

-  El equipo dispone de 2 modos de trabajo: funciones básicas (con acceso directo) y funciones avanzadas. Además de las funciones de configuración hay acceso a dos referencias de trabajo, en modo MIN, MAX y DELTA (TIR), en visualización de tolerancias o en la introducción de un factor de multiplicación distinto de 1:1. (ver cap. 3 y 4)
-  La tecla «favorito» atribuye un acceso directo a la función utilizada de manera principal (ver cap. 7).
-  Atribuye un valor predefinido, reinicializa el modo MIN/MAX, borra una selección y gestiona el apagado del equipo. Por defecto, el modo SIS permite apagar de manera automática sin pérdida de original (ver cap. 8).

- Personalización de las funciones

Es posible activar o desactivar ciertas funciones del equipo por RS232 (ver cap. 10).

- Parámetros de transmisión de datos

4800Bds, 7 bits, paridad par, 2 bits de parada

2. Arranque

Pulse un botón.

Para la conexión *Bluetooth*[®], (ver cap. 6)

3. Funciones básicas

Cada pulsación breve sobre  permite acceder directamente a las funciones básicas:

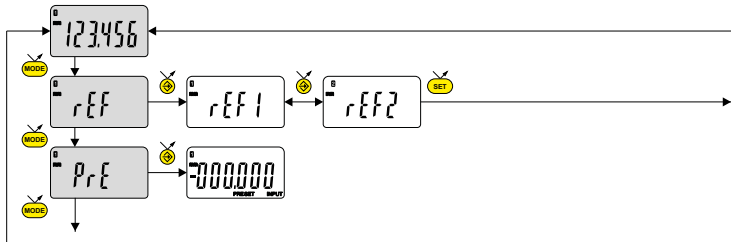

- Selección de la referencia (REF1 o REF2)

- Introducción de un valor predefinido

 dígito siguiente  0...9

 guarda el valor predefinido (PRESET)

Observaciones:

- Es posible atribuir un valor predefinido diferente a cada una de las 2 referencias. También pueden atribuirse límites de tolerancia diferentes a las referencias 1 y 2.

..... continuación

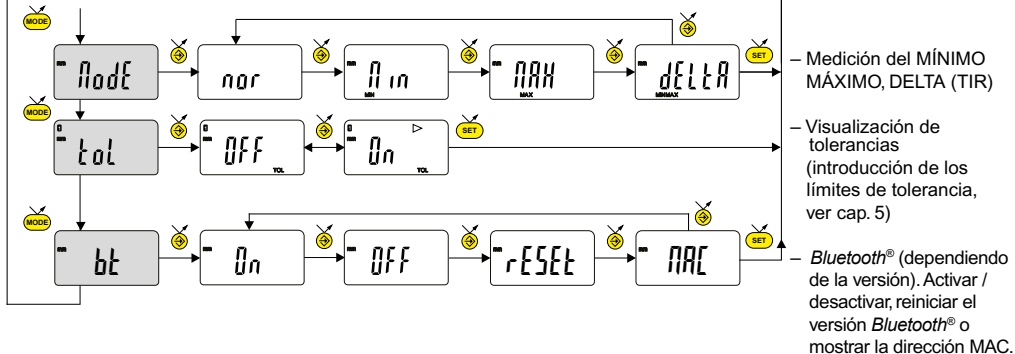

4. Funciones avanzadas

Al pulsar prolongadamente (>2 seg) sobre **MODE** accederá a las funciones avanzadas. Pulsando brevemente en **MODE** accederá a la función deseada:

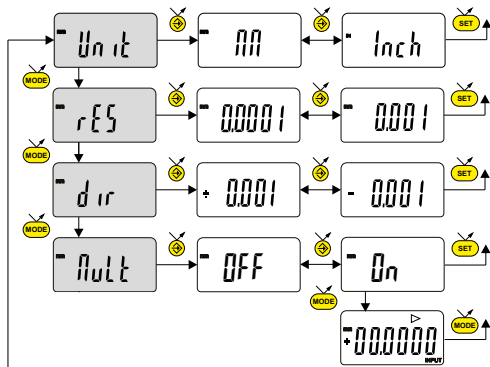

– Selección de la unidad (mm o In)

– Selección de resolución 0.01 / 0.001 o 0.001 / 0.0001 (depende de la versión)

– Selección de la dirección de medición (sentido positivo o negativo)

– Factor de multiplicación

Habilite o deshabilite el factor de multiplicación (el valor se puede cambiar si se confirma. $\overline{0}$ con el botón **MODE**).

– Introducción de un Factor de multiplicación

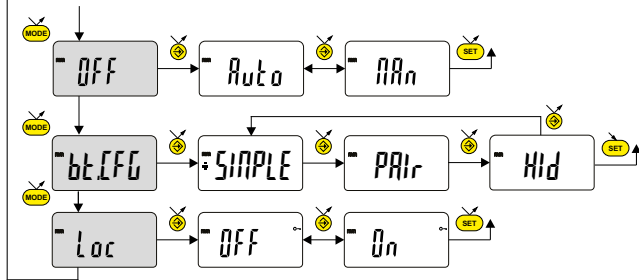

dígito siguiente 0...9 guarda MULT

..... continuación



- Modo de apagado automático
On = desactivado, Auto = activo (tras 10 min. por defecto).

- Selección del perfil *Bluetooth*[®] (según la versión).
(Ver cap. 6 para más detalles)
El símbolo + indica el perfil activo.

- Bloqueo del teclado
Solo la tecla favorito  queda activa
(para desactivar el bloqueo del teclado pulse  durante 5 segundos.).

5. Introducción de los límites de tolerancia

Para introducir o modificar los límites de tolerancia seleccione el modo *tol On* y a continuación presione brevemente

en **MODE** :

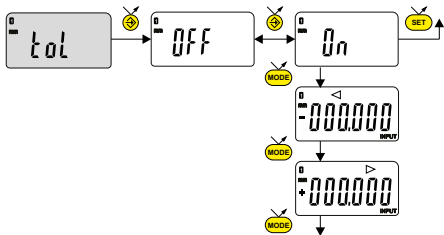



– Introduzca el límite de tolerancia inferior ◀

– Introduzca el límite de tolerancia superior ▶

MODE (con flecha) > dígito siguiente **SET** 0...9 **MODE** (con flecha) guarda el valor predefinido (TOL)



Observaciones :

- En el caso de medición de cotas de interior puede cruzar los indicadores (rojo y amarillo) invirtiendo el orden de introducción de los límites de tolerancia (límite inferior > límite superior).
- Es posible introducir límites de tolerancia diferentes en las REF1 y REF2.

- También es posible mostrar los límites de tolerancia cuando el equipo trabaja en modo MIN, MAX o DELTA (TIR)
- Si el usuario no ha definido ningún límites de tolerancia, el instrumento mostrará los indicadores de límites de tolerancias    , pero sin activar los indicadores luminosos (rojo - verde - amarillo)

6. Configuración *Bluetooth*[®] (depediendo del modelo)

El procedimiento de conexión está pensado para que sea sencillo y se caracteriza por los 3 estados siguientes :

- Símbolo  apagadomodo desconectado
- Símbolo  parpadeantemodo detección
- Símbolo  encendidomodo conectado

Se pueden seleccionar las siguientes opciones para controlar el módulo *Bluetooth*[®].

- On** Habilitar el módulo *Bluetooth*[®] (iniciar el modo de advertencia).
- OFF** Desactiva módulo *Bluetooth*[®] (terminar la coexión activa).
- rESEt** Eliminar su información de emparejamiento.
- MAC** Muestra la dirección MAC (Media Access Control).

Tres perfiles de *Bluetooth*[®] están disponibles.

SIMPLE Perfil no apareado (por defecto).

PAIR Perfil apareado y seguro.

HID Modo teclado virtual (compatible con equipos recientes sin instalación del controlador).

Observaciones :

- La información de *Bluetooth*[®] se borra cuando se cambia el perfil.

Conexión :

- 1 Compruebe que la aplicación y el *Bluetooth*[®] compatibles están activos (PC, unidad de medida).
- 2 Encienda el dispositivo. El módulo *Bluetooth*[®] está activo por defecto y el dispositivo es conectable (modo detección).
- 3 En cuanto se detecta el dispositivo, la conexión es automática. Si la conexión no se establece, durante que el instrumento se encuentre en modo búsqueda, reactivar el módulo Bluetooth vía el menú *bt / On* .
- 4 El dispositivo está listo para transmitir (modo conectado)

Solo con perfil emparejamiento :

El perfil del dispositivo con el maestro es automático en la primera conexión.

Para conectar un dispositivo a otro maestro (nuevo emparejamiento), hay que eliminar su información de emparejamiento desde el menú *bt / RESET* .

6.1 Especificación *Bluetooth*[®]



| | |
|---------------------------|---|
| Banda de frecuencia | 2.4GHz (2.402 - 2.480GHz) |
| Modulación | GFSK (Gaussian Frequency Shift Keying) |
| Potencia máxima de salida | Clase 3: 1mW (0dBm) |
| Alcance | Espacio abierto: hasta 15m Entorno industrial: 1-5m |
| Autonomía | Continuous : hasta 2 meses (siempre conectados con 4 valores / seg). Saver : hasta 5 meses (El instrumento envía valor sólo cuando la posición ha cambiado). Blind/Push : hasta 7 meses (Valor se envía desde el (botón de instrumento) se puede solicitar a la computadora). |

Otras especificaciones sobre el sitio web del fabricante.

7. Tecla favorito

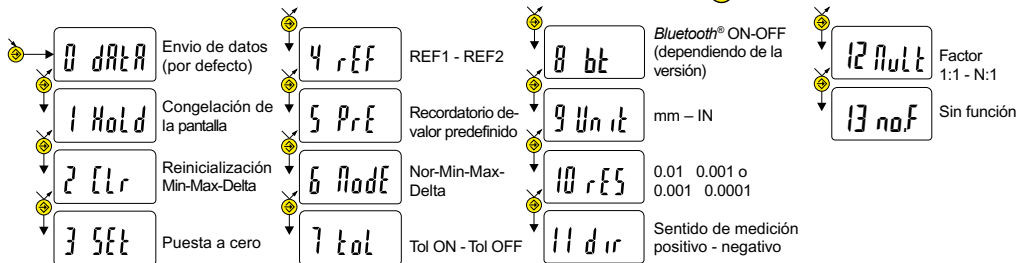
Con la tecla «favorito» se accede directamente a una función predefinida y puede configurarse según las necesidades del usuario. Para atribuir una función a la tecla «favorito» pulse prolongadamente sobre  y seleccione la función deseada:



Validación de la selección: Pulsando prolongadamente en  o brevemente en  o en 

Observaciones:

- puede atribuirse también la función por RS232 con las teclas <FCT + N° de función> (FCT 0..9 A..F)
ejemplo: Cambio de unidad de medida = <FCT9>, dirección de medición inversa = <FCTB>

8. Apagado

El comparador hibernará automáticamente tras 10 minutos de inactividad salvo que el Modo de apagado automático esté desactivado (ver Cap. 4, Funciones avanzadas)

Es posible forzar el modo de hibernación pulsando prolongadamente (> 2 seg) sobre  :

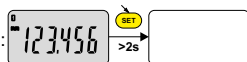

En modo hibernación el sensor conserva el valor original (modo SIS) y el equipo se reanuda automáticamente por un movimiento de la tecla de medición por control RS, o pulse un botón.

Es posible apagar el equipo en períodos largos en los que no se utilice pero esto implicará una puesta a cero al arrancarlo de nuevo (pérdida del origen):

- Pulsar prolongadamente (> 4 seg) sobre  :



9. Reinicialización del equipo

Los ajustes iniciales del equipo pueden restaurarse en cualquier momento pulsando prolongadamente (> 4 seg) y al

mismo tiempo que  y  hasta que se muestre el mensaje *reset*.

10. Personalización del equipo

Es posible personalizar el acceso a las funciones de su equipo con el programa gratuito para más información, véase el sitio web del fabricante (requiere conexión de su equipo con cable Proximity o Power RS / USB, o *Bluetooth*[®]).

Esta aplicación permite:

- Desactivar o activar las funciones deseadas.
- Modificar el acceso a las funciones avanzadas (acceso directo).

11. Conexión del equipo

El equipo puede conectarse a un periférico con un cable Proximity (RS o USB), o Power-RS (Power-USB) o *Bluetooth*[®]. Consultar la página 2 para la conexión de los cables.

Los valores medidos pueden transmitirse y puede controlarse el instrumento con comandos predefinidos (lista de comandos principales en el cap. 12).

Observaciones :

- En modo Tolerancia, los indicadores luminosos de los límites de tolerancia se iluminan sólo unos segundos cuando la medición se ha estabilizado. Sin embargo se mantendrán iluminados si el instrumento está conectado y recibe alimentación con el cable Power RS (USB).

12. Lista de comandos principales

Selección y configuración

| | |
|---------------------------|--|
| CHA+ / CHA- | Cambio de dirección de medición |
| FCT0 ...9...A...F | Atribución de función «favorito» |
| MM / IN | Cambio de unidad de medida |
| KEY0 / KEY1 | Activa / desactiva el bloqueo de teclado |
| MUL [+/-]xxx.xxxx | Modificación del factor de multiplicación |
| PRE [+/-]xxx.xxx | Modificación del valor predefinido |
| REF1 / REF2 | Cambio de la referencia activa |
| STO1 / STO0 | Activa / desactiva el HOLD |
| TOL1 / TOL0 | Activa / desactiva las tolerancias |
| ECO1 / ECO0 | Activa / desactiva el modo económico |
| LCAL dd.mm.yy | Modifica fecha de última calibración |
| NCAL dd.mm.yy | Modifica fecha de próxima calibración |
| NUM x...x (hasta 20 char) | Modifica el número del instrumento |
| TOL +/-xxx.xxx +/-yyy.yyy | Introducción de los límites de tol. actuales |
| MIN / MAX / DEL / NOR | Selección del modo MIN, MAX, Delta, Normal |
| CLE | Reinicio del MIN, MAX o Delta |
| UNI1 / UNIO | Activa / desactiva el cambio de unidad |
| OUT1 / OUT0 | Activa / desact. transmisión continua de datos |
| PRE ON / PRE OFF | Activa / desactiva la función Preset |
| PRE | Recordatorio del Preset |
| SET | Puesta a cero |
| RES1 / RES2 / RES3 | Cambio de resolución |

SBY xx xx cantidad de minutos antes de la hibernación

BT0/BT1 Activa / desactiva el modo *Bluetooth*[®]
BTRST Reinicialización del emparejamiento

Pregunta

| | |
|-----------------------------------|--|
| CHA? | ¿Sentido de medición? |
| FCT? | ¿Función «favorito» activada? |
| UNI? | ¿Unidad de medida activada? |
| KEY? | ¿Bloqueo de teclado? |
| MUL? | ¿Factor de multiplicación? |
| PRE? | ¿Valor predefinido? |
| REF? | ¿Referencia activa? |
| STO? | ¿Estado de la función HOLD? |
| TOL? | ¿Valor de límites de tol. actuales? |
| ECO? | ¿Modo económico actual? |
| LCAL? | ¿Fecha de última calibración? |
| NCAL? | ¿Fecha de próxima calibración? |
| NUM? | ¿Número del instrumento? |
| ? | ¿Valor actual (modo Tol, valor seguido de <=>)? |
| MOD? | ¿Modo activo? (MIN, MAX, Delta o Normal) |
| SET? | ¿Configuración principal del instrumento? |
| ID? | ¿Código de identificación del instrumento?OUT1 / |
| Funciones de mantenimiento | |
| BAT? | Estado batería (BAT1=Ok, BAT0=batería baja) |
| OFF | Apagado completo (arranque con botón o RS) |
| RST | Reinicialización del equipo |
| SBY | Hibernación del equipo (SIS) |
| VER? | Revisión y fecha del firmware. |

MAC? Dirección MAC del módulo *Bluetooth*[®]

13. Specifications

| | | | | | | |
|--|--|------------|-----------|----------|----------|------------|
| Alcance de la medición: | 12.5mm | 25mm | 50mm | 100mm | 150mm | |
| Error máx. (escala 10µm): | 10µm | 10µm | 20µm | 20µm | 20µm | (±1 digit) |
| Error máx. (escala 1µm): | 3µm | 4µm | 5µm | 6µm | 10µm | |
| Error máx. (escala 0.1µm): | 1.2µm | 1.6µm | --- | --- | --- | |
| Repetibilidad: | 2µm 0.3µm (escala 0.0001mm) | | | | | |
| Peso: | 119g | 123g | 161g | 208g | 265g | |
| Fuerza de medición (estándar): | 0.65-0.9N | 0.65-1.15N | 1.25-2.7N | 1.6-3.5N | 2.2-5.7N | |
| Velocidad máxima de desplazamiento: | 1.7m/seg. | | | | | |
| N1 de mediciones por segundo: | hasta 10 med/seg modo MIN/MAX: medición hasta 20 med/seg. | | | | | |
| Unidad de medida: | métrico / imperial (pulgadas) | | | | | |
| Preset máximo (escala 10µm): | ±9999.99 mm / ±399.9995 IN | | | | | |
| Preset máximo (escala 1µm): | ±999.999 mm / ±39.99995 IN | | | | | |
| Preset máximo (escala 0.1µm): | ±99.9999 mm / ±3.999995 IN | | | | | |
| Sistema de medida | Sylvac inductive system (patentado) | | | | | |
| Alimentación: | 1 batería litio 3V, tipo CR2032, capacidad 220mAh | | | | | |
| Autonomía media: | 8'000 hours (con <i>Bluetooth</i> ® habilitado, cap. 6.1) | | | | | |
| Salida de datos: | compatible RS232 / <i>Bluetooth</i> ® 4.0 (cap. 6) | | | | | |
| Temperatura de trabajo (almacenamiento): | +5 hasta +40 C (-10 hasta +60 C) | | | | | |
| Compatibilidad electromagnética: | según EN 61326-1 | | | | | |
| Especificación IP (según IEC60529): | IP 54 / IP 67 (depending on model) | | | | | |
| Fijación y volumen: | fijación Ø8h6 (3/8"), tecla de medición intercambiable M2.5 (4-48-UNF) (según DIN 878) | | | | | |

CERTIFICATE OF CONFORMITY

We certify that this instrument has been manufactured in accordance with our Quality Standard and tested with reference to masters of certified traceability by the federal institute of metrology.

CERTIFICAT DE CONFORMITE

Nous certifions que cet instrument a été fabriqué et contrôlé selon nos normes de qualité et en référence avec des étalons dont la traçabilité est reconnue par l'institut fédéral de métrologie.

QUALITÄTSZEUGNIS

Wir bestätigen, dass dieses Gerät gemäss unseren internen Qualitätsnormen hergestellt wurde und mittels Normalen mit anerkannter Rückverfolgbarkeit, kalibriert durch das eidgenössische Institut für Metrologie, geprüft worden ist.

CERTIFICATO DI CONFORMITÀ

Con il presente si certifica che questo strumento è stato prodotto secondo il nostro standard sulla qualità e controllato rispetto a campioni di riferibilità riconosciuta dall'istituto federale di metrologia.

CERTIFICADO DE CONFORMIDAD

Certificamos que este instrumento ha sido fabricado conforme a nuestras normas de calidad y ha sido controlado en relación con patrones de trazabilidad reconocida por la oficina nacional de metrología.

Calibration certificate

Because we make our instruments in batches, you may find that the date on your calibration certificate is not current. Please be assured that your instruments are certified at point of production and then held in stock in our warehouse in accordance with our Quality Management System ISO 9001. Re-calibration cycle should start from date of receipt.

Certificat d'étalonnage

En raison de la fabrication de nos instruments par lots de production, il est possible que la date de votre certificat d'étalonnage ne soit pas actuelle. Nous garantissons que nos instruments sont certifiés au moment de leur fabrication puis stockés conformément à notre système de gestion de la qualité ISO 9001. Le cycle de réétalonnage peut commencer à partir de la date de réception.

Kalibrierzertifikat

Da wir unsere Instrumente in Serien herstellen, kann es sein, dass das Datum auf dem Zertifikat nicht aktuell ist. Die Instrumente sind jedoch ab der Herstellung zertifiziert und werden dann gemäss unserem Qualitätsmanagementsystem ISO 9001 in unserem Lager aufbewahrt. Der Nachkalibrierungszyklus kann ab dem Empfangsdatum beginnen.

Certificado de calibración

Puesto que fabricamos nuestros instrumentos por lotes, puede que la fecha de su informe de prueba / certificado de calibración no esté al día. Asegúrese de que los instrumentos estén certificados en nuestro lugar de producción y estén almacenados en nuestro almacén conforme a nuestro sistema de control de calidad ISO 9001. El ciclo de recalibración puede empezar a partir de la fecha de recepción.

Certificato di taratura

Considerata la nostra produzione in serie di strumenti, è possibile verificare che la data di produzione sul rapporto di prova / certificato di taratura non è attuale. Accertarsi che gli strumenti siano correttamente certificati dalla nostra produzione e che sono conservati in stock presso il nostro magazzino secondo il sistema di gestione della qualità ISO 9001. Il ciclo di nuova taratura può essere avviato dalla data di ricezione.

The *Bluetooth*® word mark and logos are registered trademarks owned by the *Bluetooth*® SIG, Inc. and any use of such marks by Sylvac is under license. Other trademarks and trade names are those of their respective owners.

U.S./Canada Certification

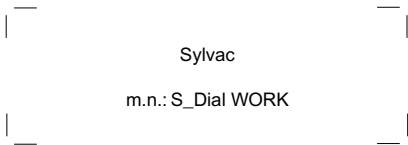

m.n.: S_Dial WORK

This device contains
FCC ID: 2AAQS-ISP091201
IC: 11306A-ISP091201

NOTICE:

Changes or modifications made to this equipment not expressly approved by Sylvac may void the FCC authorization to operate this equipment.

NOTICE :

This device complies with Part 15 of the FCC Rules and with RSS-210 of Industry Canada. Operation is subject to the following two conditions.

- (1) this device may not cause harmful interference, and
- (2) this device must accept any interference received, including interference that may cause undesired operation.

NOTE :

This equipment has been tested and found to comply with the limits for a Class A digital device, pursuant to Part 15 of the FCC Rules. These limits are designed to provide reasonable protection against harmful interference when the equipment is operated in a commercial environment. This equipment generates, uses, and can radiate radio frequency energy and, if not installed and used in accordance with the instruction manual, may cause harmful interference to radio communications. Operation of this equipment in a residential area is likely to cause harmful interference in which case the user will be required to correct the interference at his own expense.

Radiofrequency radiation exposure Information :

This equipment complies with FCC radiation exposure limits set forth for an uncontrolled environment. This equipment should be installed and operated with minimum distance of 20 cm between the radiator and your body.

This transmitter must not be co-located or operating in conjunction with any other antenna or transmitter.

Brazil Certification

Description :

This module is based on Nordic Semiconductor nRF8001 μ Blue *Bluetooth*[®] Low Energy Platform. The nRF8001 is a single chip transceiver with an embedded baseband protocol engine, suitable for ultra-low power wireless applications conforming to the *Bluetooth*[®] Low Energy Specification contained within v4.0 of the overall *Bluetooth*[®] specification. The nRF8001, used in the current revision of ISP091201, is a production product using a RoM for the baseband protocol engine.

Este equipamento opera em caráter secundário, isto é, não tem direito à proteção contra interferência prejudicial, mesmo de estações do mesmo tipo e não pode causar interferência a sistemas operando em caráter primário.



Mexico certification

Contiene modulo inalámbrico
Marca: Sylvac
Modelo: ISP091201D
IFT: RCPSYIS14-0655

La operación de este equipo está sujeta a las siguientes dos condiciones: (1) es posible que este equipo o dispositivo no cause interferencia perjudicial y (2) este equipo o dispositivo debe aceptar cualquier interferencia, incluyendo la que pueda causar su operación no deseada.

Korea South certification

MSIP-CRM-iNs-ISP091201

Class A Equipment (Industrial Use)

이 기기는 업무용(A급) 전자파적합기기로서 판매자 또는 사용자는 이 점을 주의하시기 바라며, 가정 외의 지역에서 사용하는 것을 목적으로 합니다.

Japan certification



R

001-A06167

Taiwan Certification

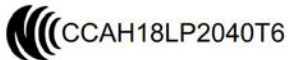

警語

經型式認證合格之低功率射頻電機,非經許可,公司、商號或使用者均不得擅自變更頻率、加大功率或變更原設計之特性及功能。

低功率射頻電機之使用不得影響飛航安全及干擾合法通信;經發現有干擾現象時,應立即停用,並改善至無干擾時方得繼續使用。

前項合法通信,指依電信法規定作業之無線電通信。低功率射頻電機須忍受合法通信或工業、科學及醫療用電波輻射性電機設備之干擾。

Notes / Notes / Notizen / Note / Notas ...

Notes / Notes / Notizen / Note / Notas ...

UK
CA



Changes without prior notice

Sous réserve de toute modification

Änderungen vorbehalten

Soggetto a modifica senza preavviso

Reservados los derechos de modificación sin previo aviso

Edition: 2021.07 / 681.289.01-120